



The Actros.

Long-distance transport. 18-44 tonnes GCW.
Heavy haulage. Up to 250 tonnes GCW.

Mercedes-Benz

Trucks you can trust



RoadStars: Come aboard – it's worth it.

RoadStars. RoadStars is the Mercedes-Benz interactive communication platform for drivers, operators and anyone interested in trucks – you too can become part of the extensive RoadStars community. Registered users are kept up to date with the latest information on a regular basis. You also have the opportunity to get more involved, for example by commenting, uploading pictures, chatting or sharing content.

As a member you can join in exclusive events, offers and experiences at Mercedes-Benz Trucks. Whether you use a smartphone, tablet, laptop or desktop computer – an internet connection is all it takes to access RoadStars at any time, wherever you are. Join in now and become a genuine RoadStar:
www.roadstars.mercedes-benz.com



Contents.

Mercedes-Benz: long-distance transport	4–5	The Actros SLT – up to 250 tonnes GCW	56–63
The Actros up to 44 tonnes GCW	6–7	At a glance	58–59
Comfort	8–21	Transmission, engine	60–61
Working comfort	10–13	Frame, axles, detachable body components	62–63
Cab comparison	14–15	Genuine accessories	64–67
Living and sleeping comfort	16–21	Technical data	68–81
Economy	22–43	Actros rigids	68–75
Low overall costs	24–39	The Actros SLT	76
High level of safety	40–41	Engine performance data	77
High level of vehicle usability	42–43	Tank variants	78
Driving dynamics	44–49	Cab variants	79–81
Drive technology	46–47		
Frame, chassis, suspension	48–49		
Sector-specific vehicle concepts	50–55		
Actros Loader	52–53		
Actros Volumer	54–55		



Mercedes-Benz: long-distance transport.



Long-distance transport from Mercedes-Benz. If you want to stay ahead, you need vehicles which deliver top performance not just on the road, but on your balance sheet, too. The Actros has what it takes to excel in both respects. Because it provides a high level of comfort. Because its many fuel-saving, innovative technical features and perfectly matched support services make it distinctly profitable to operate. Because it offers an effortless, safe and superior driving experience. And because the wide range of equipment and model versions means that it is possible to configure a truck which is a perfect match for practically any long-distance haulage task.

There is also a compelling case for the Actros in the heavy haulage sector. The Actros up to 250 tonnes GCW offers you a range of tractor units which have been specially developed for moving particularly heavy, large loads and which are outstandingly robust, flexible and well matched to the task.

Get on board – and discover what Mercedes-Benz can do for you in the long-distance transport sector.



4.1

Tor
Gate 4

S MB 1849

More than just economical. The Actros.

Comfort. With a total of eleven application-oriented cab variants, the Actros offers outstanding working, living and sleeping accommodation solutions for every application in the long-distance transport sector. In addition to the light, friendly ambience and the distinct separation of workplace and living space, the headroom of up to 2.13 m between the seats, the great freedom of movement along with plenty of stowage space and comfortable beds ensure optimum comfort for working, living and sleeping.

Economy. The excellent overall economy of the Actros is the result of a number of different factors. For example, it comes equipped with particularly fuel-efficient technology while a wide range of service offers can make for even greater cost-effectiveness and vehicle availability. Furthermore, coordinated services, such as FleetBoard and Mercedes-Benz Finance can also contribute to low running costs. Driver training courses also play a role. Another plus point where cost-effectiveness is concerned: guaranteed residual values either directly through Mercedes-Benz UK or via a suitable Mercedes-Benz Finance product.

Dynamic handling. For an optimal driving experience, we have equipped the Actros with an innovative rear axle guide for 4x2 vehicles, a sensitive steering system and a wide, rigid frame. The responsive engines, which are available in a total of 18 power output ratings with up to **460 kW** (625 hp), work in conjunction with the Mercedes PowerShift 3 automated transmission to provide economical driving enjoyment.

Industry-specific vehicle concepts. If the ability to carry a heavy payload is a key requirement, the Actros Loader is the right choice. For volume-oriented applications, the Actros Volumer is the right solution.



Comfort that is geared to the driver. And to the task in hand.

True greatness right down to the smallest detail – the Actros completely redefines terms such as freedom of movement, sense of spaciousness and atmosphere, without losing sight of what matters in the course of the driver's everyday work. In short, working, living and sleeping comfort which is geared to the work of long-distance drivers and meets their high expectations, too.

Comfort. A modern workplace, an attractive living area and at the same time a place for restful sleep – the cabs of the Actros live up to these requirements in every respect. This is especially true of the GigaSpace, in which the exceptionally high comfort which makes the Actros such an outstanding player in the long-distance transport sector can be experienced in its most compelling form. For example, there is the impressive headroom of 2.13 m between the seats and the excellent balance between stowage capacity and freedom of movement.

Perfect ergonomics and practical solutions are the defining characteristics of the workplace in the Actros – and what sounds so simple and feels so good when out on the road is actually the result of a whole series of components which have been finely matched in both ergonomic and functional terms. These include the cockpit, which is ideally suited to the driver's needs, the comfortable seats and the multifunction

steering wheel. Everything can be operated intuitively and is precisely tuned to work processes in long-distance transport. Crucial factors for the pleasant atmosphere in the Actros are the homely interior design with its friendly colour concept, the clear design idiom and the high-quality, perfectly finished and easy-to-clean materials, plus the clear separation of workplace and living area.

The well-thought-out living concept ensures maximum relaxation during breaks. Restful sleep comes courtesy of the comfortable beds. Furthermore, practical details and interior designs increase the sense of well-being and add a distinctly personal touch to the Actros as far as cab comfort is concerned.

¹⁾ Optional equipment.



Multifunction key¹⁾. It offers all the functions of an extended central locking system and allows the tyre pressure and lighting checks to be carried out. It also serves as a remote control for features such as the radio and the auxiliary heating.

Comfort and working - no contradiction for us. But a given.

Well-being in the workplace. This is a key requirement for stress-free driving. And a promise which the Actros cabs live up to on every trip with their ergonomics as well as their equipment and details which are matched precisely to the work processes involved in long-distance transport.

Engine start/stop button. One finger is all it takes to start and stop the engine: just press the engine start/stop button - that's all there is to it.

Your workplace in the Actros. The workplace with its cockpit that is ideally suited to the driver's needs offers excellent working conditions. From the engine start/stop button to the multifunction steering wheel and instrument cluster with

colour display to the ergonomically arranged controls and the well thought-out stowage facilities in the instrument support - everything helps ensure that drivers can concentrate on their work in a relaxed manner.



Multifunction steering wheel. With eight control buttons on both the right and left, it is possible to control many functions. For example, telephone calls can be answered, assistance systems can be operated and radio settings can be adjusted.

Mercedes PowerShift 3 Superior dynamic response, simple handling and low fuel consumption: the automated transmission ensures precise gear selection, short shift times, high driving comfort and optimal economy. The “economy” driving mode supports a particularly economical driving style, the “power” mode a very dynamic one. The fleet driving program is pre-set to use “fleet” driving mode.

10.4 cm instrument cluster. With its numerous new functions and displays, the on-board computer presents all the key information quickly, comprehensively and clearly.

12.7 cm instrument cluster with video function¹⁾. For even greater convenience and safety, this instrument cluster is prepared for use with a reversing camera²⁾. This allows the driver to see the area behind the vehicle. With its numerous functions and displays, the unit with its graphics-capable display provides a fast and comprehensive overview and simplifies the departure check.

¹⁾ Optional equipment.

²⁾ A reversing camera is available from Mercedes-Benz Accessories.



Truck operating instructions. In addition to its many other functions, the radio/navigation system with Bluetooth^{®1)} includes the vehicle operating instructions in digital form which the driver can use to learn about the Actros in detail.

Intuitive menu navigation. The straightforward menu navigation concept of the instrument cluster makes all the key information available quickly, clearly and on a non-reflective display. Settings can be made by means of the multifunction steering wheel.



Seats. All the seats impress with a high level of comfort. The controls are arranged intuitively, the seat cushions are particularly wide and the adjustment range particularly large: lengthwise up to 250 mm, for height up to 120 mm.

Comfort suspension seat¹⁾ The air-suspended seat can be adjusted to meet the individual occupant's requirements and provides the best ergonomic basis as well as a great deal of comfort. The integrated seat heating contributes to this comfort. The comfort suspension seat is equipped with pneumatic height adjustment, seat cushion angle and depth adjustment and an integrated headrest with integrated, height-adjustable 3-point automatic seat belt.

Air-conditioned suspension seat²⁾ The optional, air-suspended, climatized driver's suspension seat provides pleasant seating conditions and a high level of comfort. The integral armrests and the seat heating also contribute to this. The active ventilation system in the backrest and cushion of the climatized suspension seat reduces heat and moisture build-up. The numerous individual adjustment options make for optimal ergonomics.



Bluetooth® Radio Navigation System²⁾ Equipped with a 17.4 cm colour display as well as Bluetooth® and convenience features, the system leaves nothing to be desired when it comes to support for the driver and entertainment.

Massage function for driver's seat²⁾ The massage function prevents the driver from suffering from muscular tension problems, so their comfort is maintained for longer.

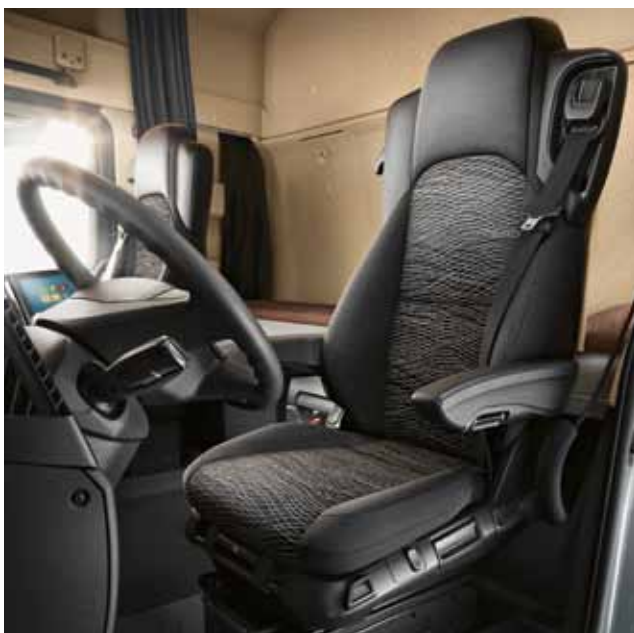

Heating and air-conditioning system. The system is characterised by its immediate response and facilitates draught-free ventilation.

Auxiliary air conditioning²⁾. The system can air condition the cab for up to eight hours. It saves fuel and operates quietly as it is not necessary for the engine to be idling.

Hot-water auxiliary heating³⁾. Complementing the heating system, it heats the cab when the outside temperature is very low to provide a comfortable environment for an overnight stay.

Residual engine heat utilisation. Once the engine has been switched off, the cab can be heated by the residual heat of the engine coolant for up to another two hours.



Automatic climate control²⁾. The system automatically adjusts the air volume, distribution and temperature in line with the ambient conditions and offers additional comfort and convenience functions.



¹⁾ Optional equipment, standard for BigSpace and GigaSpace.

²⁾ Optional equipment.

³⁾ Version for cab and engine heating also available.

⁴⁾ Version for cab and engine heating not available in conjunction with 320 mm engine tunnel.



Advantages at a glance.

- Ergonomically designed driver's workplace with engine start/stop button
- Multifunction key²⁾
- Multifunction steering wheel which can be operated intuitively, with wide adjustment range
- Easily legible instrument cluster with a 10.4 cm TFT colour display
- Instrument cluster with 12.7 cm TFT colour display and video function²⁾
- Automated transmission operated via steering-column lever
- Wide range of seats designed to maintain occupant fitness, with numerous adjustment options
- Extensive multimedia range including Truck navigation²⁾ as well as sound system²⁾
- Innovative, air-controlled heating and air conditioning system
- Automatic climate control²⁾ and auxiliary air conditioning²⁾ for even greater comfort
- Optional innovative residual engine heat utilisation system
- Hot-water auxiliary heating²⁾ for engine and/or cab⁴⁾



Cab variants. With eleven cab variants in two widths, with five roof shapes (CompactSpace, ClassicSpace, StreamSpace, BigSpace and GigaSpace) and three engine tunnel variants (320 mm, 170 mm, level floor), the Actros covers practically all requirements in terms of space, equipment and comfort.

ClassicSpace L-cab, 2.30 m, tunnel 320 mm. The comfortable 2300 mm-wide cab offers the driver an ergonomic, comfortable workplace and is ideally designed to meet the requirements of regional long-haul transport.

ClassicSpace L-cab, 2.30 m, Tunnel 170 mm¹⁾. The comfortable cab has been designed in accordance with the latest ergonomic and safety principles and offers the driver a high level of comfort and a pleasant ambience.

StreamSpace L-cab, 2.30 m, tunnel 170 mm¹⁾. Thanks to its low air resistance, the cab plays a role in the truck's particularly low fuel consumption. It is designed in accordance with modern ergonomic standards and offers 1.79 m of headroom between the seats.

StreamSpace L-cab, 2.30 m, level floor¹⁾. The cab has been specially optimised for low fuel consumption. Thanks to the level floor it has a headroom of 1.97 m between the seats

and is therefore very spacious. The cab has been designed in accordance with the latest ergonomic and safety principles and offers high levels of comfort and convenience. The level floor makes for additional freedom of movement and facilitates through-cab access to the co-driver's side.

StreamSpace L-cab, 2.50 m, level floor¹⁾. The cab has been specially optimised for low fuel consumption. Thanks to its width and the headroom of 1.97 m between the seats, it offers plenty of space and a high level of comfort. The cab has been designed in accordance with the latest ergonomic and safety principles; the level floor facilitates through-cab access to the co-driver's side.



ClassicSpace cab, 2300 mm wide, engine tunnel 170 mm



StreamSpace cab, 2300 mm wide, level floor



StreamSpace cab, 2500 mm wide, level floor

BigSpace L-cab, 2.50 m, level floor¹⁾. With headroom of 1.99 m between the seats, the level-floor cab offers exceptional freedom of movement and easy access to the co-driver's side. A large interior and generous stowage facilities assure driver and co-driver of ample space and provide for relaxed breaks and rest phases in the cab. Numerous stowage compartments and spaces keep the cab tidy.

GigaSpace L-cab, 2.50 m, level floor¹⁾. The width and the impressive 2.13 m of headroom between the seats mean that this cab – the largest and most comfortable in the Actros line-up – is ideally suited to the space requirements of two-person crews. The generous amount of interior and stowage space ensures that the driver and co-driver have plenty of freedom of movement and numerous stowage facilities. This makes for relaxing rest periods and keeps the cab tidy.



BigSpace cab, 2500 mm wide, level floor



GigaSpace cab, 2500 mm wide, level floor



Advantages at a glance.

- Five cabs: CompactSpace, ClassicSpace, StreamSpace, BigSpace and GigaSpace
- Two cab widths: 2500 mm and 2300 mm
- Eleven cab variants for use in national and international long-distance transport
- Level floor for 2500 mm wide cabs
- Engine tunnel available in two heights in 2300 mm wide cabs
- Level floor for 2300 mm wide cabs¹⁾
- Impressive headroom of up to 2.13 m

¹⁾ Optional equipment.



Better living when out on the road – as of now.

At first glance – and after thousands of kilometres: the interior design of the Actros with the well thought-out living concept ensures maximum relaxation during breaks.

Interior design. The Actros stands for excellent living comfort – because the driver was the focus of attention during the development and design of the cabs: the result is freedom of movement aplenty and lots of stowage space combined in an effective, functional interplay. The choice of colours and materials creates a welcoming ambience and a pleasant sense of space while simultaneously underlining the distinct separation of workplace and living area.

Step lighting. The comfort-enhancing details of Actros cabs with a level floor include the step lighting which makes entering the vehicle easier and safer.

Additional socket¹⁾ 12 V 15 A, co-driver's footwell. The power socket in the co-driver's footwell on the side of the centre section of the instrument support serves to operate 12 V electrical devices such as a coffee machine, TV or laptop.



Style Line interior design¹⁾. The many metal-look or chrome-look trim elements as well as velour carpet inserts give the cab a contemporary ambience. Classy interior features include the applications on the steering wheel and the steering column levers, as well as the air vent surrounds and the door handles. Exterior highlights include the chrome strip on the sun visor and the mirror covers.

Basic Comfort Pack¹⁾. This comfort package for tractor units and chassis provides a cost-effective selection of components for greater comfort and convenience. Features of the Basic Comfort Pack include the electric sunblind for the windscreen, the ambient lighting, and a 2-way speaker system.

Classic Comfort Pack¹⁾. The comfort package for tractor units and rigids comprises numerous exterior and interior equipment features. The Classic Comfort Pack comprises a total of 10 equipment items, such as an electrically operated tilting/sliding sunroof, sunblinds for the side windows and a leather steering wheel.

Top Comfort Pack¹⁾. The comfort package which is available ex-factory allows the cab to be made even more comfortable and individual with a large number of useful interior features. The Top Comfort Pack contains 15 equipment items: these include the 36 l refrigerator, the sound system, the automatic climate control as well as the illuminated Mercedes star.

¹⁾ Optional equipment.



Table, on co-driver's side. The optional folding table is integrated in the instrument support and can be folded out and in again quickly for working or eating.



Home Line interior design¹⁾. Wood trim, a velour carpet insert and warm colours enhance the look and feel of the interior and create a warm and extremely homely atmosphere. The wood-effect finish is used on the interior door handles and the trim strips on the instrument panel on the co-driver's side, on the seat base and on the hand brake valve which is also enhanced by a leather sleeve.



Ambient lighting¹⁾. This subtle, dimmable blue interior lighting, creates a particularly cosy effect and better orientation during breaks or when driving in the dark.

An abundance of stowage space and stowage options. For one or two drivers - and to meet the most discerning standards.

Anyone who spends a lot of time on the road needs space of their own. And space for the essentials needed on long journeys. This is why the cabs of the Actros offer particularly spacious interiors - with vast amounts of stowage space and plenty of freedom of movement.

Stowage lockers, above windscreen, with valuables compartment¹⁾. Instead of an open stowage facility, a lockable compartment for valuables is integrated above the windscreen on the co-driver's side. The hinges and the lock, which has a separate, mechanical key, are reinforced to resist break-in attempts.

Drawer under the instrument support. In cabs with a level floor, a drawer beneath the instrument support provides easily accessible stowage space.



Stowage compartments above the windscreen. Thanks to the layout of the stowage compartments above the windscreen, the GigaSpace offers not only a huge amount of stowage capacity but also excellent freedom of movement. Equipped with hinged covers, the stowage compartments are illuminated on the inside, fitted with anti-slip felt and offer enough space for all the items required by two drivers.

Stowage tray, low²⁾. It is fitted on the engine tunnel between the driver's and co-driver's seats and is equipped with two cupholders and an ashtray receptacle.

Stowage facility, high²⁾. With a capacity of 15 l, it provides space for items required in the course of everyday work and so helps keep the cab tidy. Furthermore, it enables safe access to the upper bed.

Luggage rack, top²⁾. This item takes the form of a luggage net fitted on the rear wall of the cab. Numerous items required in everyday use can be accommodated easily in the large net which can be used flexibly.



Drawer under the bed. In cabs with an engine tunnel a practical drawer with a capacity of 51 l is housed in the centre section beneath the bed. A refrigerator²⁾ with a capacity of 26 l is also available instead of the drawer.

¹⁾ Optional equipment, only available for GigaSpace and BigSpace cabs.

²⁾ Optional equipment.

³⁾ Standard in conjunction with SoloStar Concept (LHD only).

⁴⁾ Also for StreamSpace with width of 2500 mm.

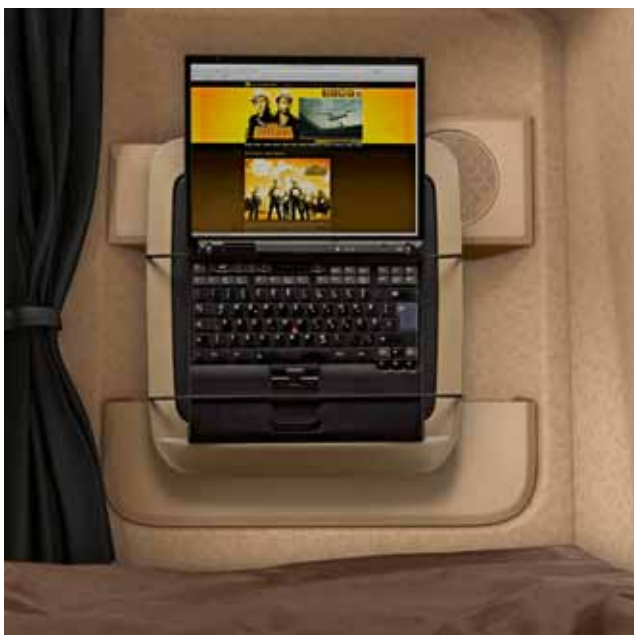

Notebook holder³⁾. The holder provides a secure support for laptops and can simply be clipped into the open stowage facility above the windscreen or onto the side wall on the co-driver's side.



Drawers under the bed. The GigaSpace and BigSpace are equipped with two spacious drawers, one of which can take the form of a refrigerator²⁾ with a capacity of 36 l, in which drinks bottles can be carried standing upright⁴⁾.



Exterior stowage compartments. With a capacity of up to 420 l, the two stowage compartments under the bed which can be accessed from both the inside and outside offer a huge amount of stowage space. Two adjustable stowage trays²⁾ are available to allow better use to be made of the space.

Comfortable living and sleeping accommodation on the road. Welcome home.

With the extremely comfortable beds, the Actros has all the qualities that really count when it comes to living and sleeping comfort in the long-distance transport sector. Qualities that no-one would want to do without once they have experienced them.

SoloStar Concept¹⁾. For intercontinental transport operations, the cab design provides for comfortable rest periods. Available for left-hand drive vehicles only, the SoloStar Concept has a distinctly homely character with exceptional comfort for resting and sleeping as well as numerous equipment options. It is particularly suited to solo drivers. The central element is the comfortable seat against the back wall of the cab, in which you can stretch out your legs. It is equipped with a head restraint and an integral 3-point automatic seat belt to allow the vehicle to be operated with a crew of two. Getting changed in the cab is also easy – as is eating thanks to the fold-down table with cutlery compartment. Restful sleep is assured by the 7-zone cold-foam comfort mattress.

Mattresses. Restful sleep is assured by the 7-zone cold-foam comfort mattress. Even greater comfort is provided by the PremiumComfort¹⁾ multizone mattress which is available for both the upper and the lower bed.

Additional comfort. The wrap-around curtain, a reading light and controls (accessible from the bed) for the radio, light, pop-up roof as well as the auxiliary heater and auxiliary air conditioning¹⁾ make for even greater comfort when resting or sleeping.



SoloStar (LHD only) seat. The central element of the spacious living area is the extremely comfortable seat against the back wall of the cab. It invites you to sit down, stretch out your legs and relax – and also provides a pleasant place to sit when eating.



Comfort bed, top, wide, with levelling control^{2) 3)}. Very high levels of comfort for relaxing and sleeping are offered by the upper comfort bed with its 7-zone cold foam mattress. It has an adjustable levelling control to compensate for inclination in the direction of travel; this means that a level sleeping area is maintained, even if the truck is parked on a slope. The upper comfort bed for L-cabs is 750 mm wide and 2000 or 2200 mm long, depending on the cab width. The mattress is 110 mm thick and is equipped with a sprung base which also provides for efficient ventilation. Also included are a wrap-around curtain and a control panel for various comfort functions.



Comfort bed, bottom. Maximum comfort for relaxing and sleeping in all L-cabs: this is ensured by the dimensions of 750 mm wide and 2000 mm long (for 2.3 m cabs) or 2200 mm long (for 2.5 m cabs). A one-piece, high-quality, 110 mm thick cold foam mattress with 7 zones and a sprung base provides individual support for the different parts of the body while also ensuring efficient under-mattress ventilation.



Advantages at a glance.

- High-quality, attractive interior design with distinct separation of workplace and living area
- Home-Line¹⁾ and Style-Line¹⁾ interior designs
- Comfort Packs¹⁾ offer enhanced comfort on attractive terms
- Huge range of stowage facilities and compartments – also for two-person crews
- Stowage capacity of up to 332 l above windscreen
- Stowage compartments beneath the bed with a capacity of up to 558 l
- Refrigerator¹⁾ with capacity of up to 36 l
- Folding table¹⁾ for the co-driver side integrated in the instrument support
- Comfortable beds up to 2200 mm long and 750 mm wide
- Upper comfort bed with level control and a width of 750 mm^{2) 3)}
- Upper comfort bed with a width of 600 mm¹⁾
- 7-zone comfort mattress or PremiumComfort mattress¹⁾

¹⁾ Optional equipment.

²⁾ Standard in conjunction with SoloStar Concept.

³⁾ Not available for ClassicSpace L-cab.





Comprehensive solutions for greater transport efficiency.

These days, particularly low overall costs and rising earnings can no longer be achieved just by having economical and reliable vehicles. Operating safely is also a decisive factor for high transport efficiency. Along with services which increase vehicle availability even further. From day one. And throughout the entire period of use.

Comprehensive transport efficiency. There are plenty of ways to operate even more efficiently. By reducing vehicle-related costs such as acquisition, fuel consumption, maintenance and repairs, Mercedes-Benz contributes to making even better use of your vehicle's vast potential for boosting profitability: with innovative vehicle technology and services tailored perfectly to individual needs. The following pages will give you a detailed overview of the levers we are able to offer you for achieving even more economy with regard to vehicle-related costs. And you can also make savings on the road: in addition, FleetBoard supports optimised vehicle capacity utilisation and helps reduce personnel and administration costs. Just take a look for yourself!



High overall economy. The combination of efficient, reliable vehicle technology, leading safety technologies and services makes it possible to reduce overall costs and therefore to increase earnings. With every kilometre.

We do everything. To ensure particularly low overall costs.

Low costs. Right from the start and during the entire period of use. Through vehicles with innovative technology and with services which you can select when you place your order – and which pay right from day one. Because they are precisely tailored to your long-distance transport requirements. Because the right investment is the best investment.

Vehicle. A good investment must meet all your requirements. And this is another area in which the Actros delivers an exemplary performance. Because it was specially developed for long-distance transport and therefore offers the best basis for particularly economical operation: the economical Euro VI engines are available in four displacement classes from 7.7 l to 15.6 l and a total of 18 power output ratings from **175 kW** (238 hp) to **460 kW** (625 hp). For a further reduction in fuel consumption, the second generation versions of the 10.7 l OM 470 engine and the 12.8 l OM 471 engine are now also available. In conjunction with the precisely tuned powertrain configurations and the sophisticated aerodynamics, these engines achieve fuel savings of up to 5% (OM 470) and 6% (OM 471) compared with the predecessor model. If you work in the payload- or volume-oriented sectors, our Actros Loader and Actros Volumer are designed to meet your needs. See pages 50–55 for further information.



Application Information Centre (BIC). The Application Information Centre in Würth offers a permanent display of around 180 industry-specific complete vehicles with body solutions from over 70 manufacturers. All the vehicles and body solutions can be test-driven, demonstrated, tried out and directly compared with each other under real-life conditions so that the optimal transport solution can be found quickly and easily. We also offer sector-specific events with driving experience opportunities.

Mercedes-Benz Custom Tailored Trucks (CTT). Made-to-measure body building. Mercedes-Benz Custom Tailored Trucks extends our wide portfolio of trucks and supplies products which meet your special requirements with all the benefits of proven Mercedes-Benz quality: from the detailed consultation stage and definition of the conversion specification, through the design engineering, simulation and testing phases all the way to delivery, we are your single point of contact for the entire project. Supported by selected partners, CTT is able to meet individual customer requirements – for complex axle and chassis modifications for special bodies or the repositioning of components, for example. In short, Mercedes-Benz Custom Tailored Trucks provides the precise solution you need for your application. So you can operate economically.



Advantages at a glance.

- Application-optimised vehicles for long-distance transport
- Comprehensive range of engines with four displacement classes from 7.7 l to 15.6 l and a total of 18 power output ratings from 175 kW (238 hp) to 460 kW (625 hp) as well as precisely tuned powertrain configurations
- Industry-specific Loader and Volumer vehicle concepts
- Application Information Centre in Würth with approx. 180 practical, sector-specific solutions available for hands-on access, testing, comparison and test-driving as well as sector-specific events with driving experience opportunities
- Mercedes-Benz Custom Tailored Trucks for custom bodies and conversions



Our tip for low fuel consumption costs: Top technology, top services and a top driving style.

In the Actros you have a vehicle which uses fuel extremely efficiently. What's more: through the combination of vehicle technology and services, such as our driver training, further significant reductions in fuel costs are possible. An accomplished driver can make a good truck even better.

Engine technology and emission control technology. The 6-cylinder in-line engines used in the Actros impress with up to 5% lower fuel consumption with Euro VI compared with their already frugal Euro V predecessors. This is due to the particularly efficient combustion strategy; in short, lower fuel consumption and therefore considerably lower CO₂ emissions as well as reduced particulate and nitrogen oxide emissions.

High Performance Engine Brake¹⁾. A higher-power three-stage, wear-free auxiliary brake offering up to **475 kW** of brake power²⁾ is available for even greater safety.

Axles, transmissions, ancillaries. A wide choice of rear axle ratios matched to various operating profiles also plays a role in keeping fuel consumption low. What's more, short shift times and the "economy" or "fleet" driving programs also support an economical driving style. Economical ancillary consumers, such as the on-demand compressed-air control system and the power steering pump also contribute to low fuel consumption.

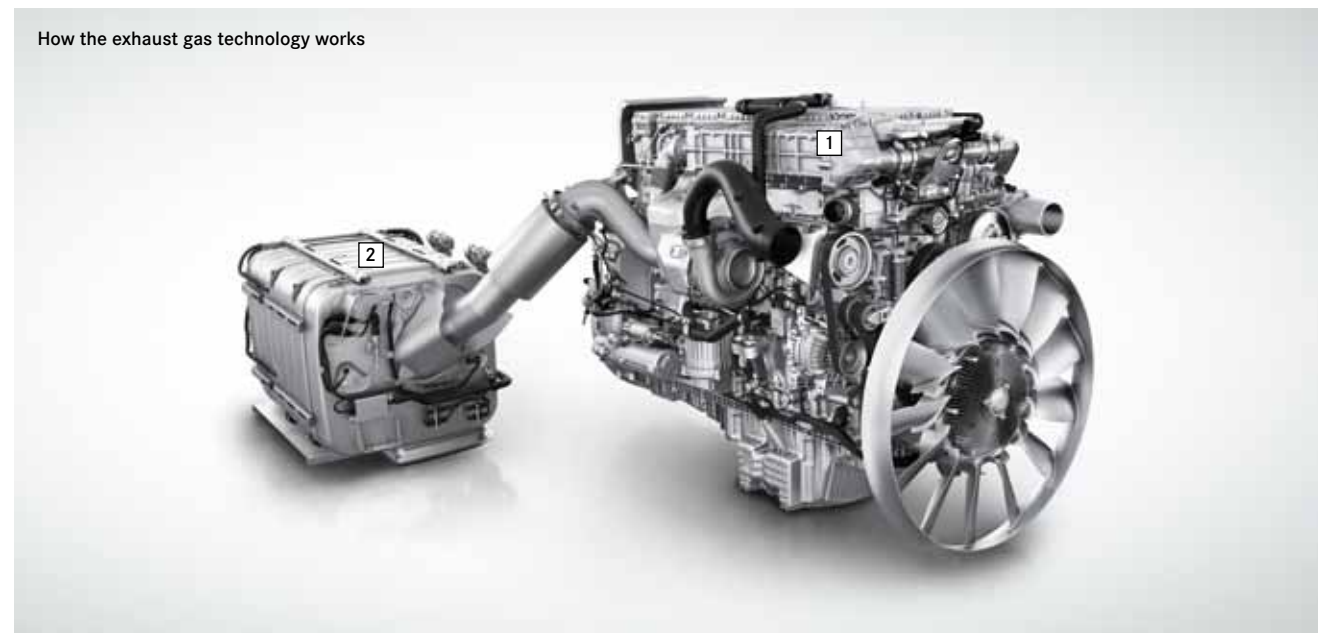

Euro VI exhaust emissions technology. 1. Thanks to the cooled exhaust-gas recirculation system, less nitrogen oxide and fewer particulates are produced during combustion. 2. Particulate emissions are almost entirely prevented by the closed diesel particulate filter. Thanks to the optimised metering unit, the AdBlue[®] is injected into the exhaust flow without air. The nitrogen oxides are converted entirely into water and nitrogen by the SCR catalytic converter.

Low drag and rolling resistance. The design of the Actros has been optimised right down to the smallest detail in order to reduce wind resistance. This is especially apparent on the StreamSpace cab. The electronically controlled radiator shutter³⁾ and door shutters⁴⁾ also save fuel. Air management kits⁵⁾ and the tyre pressure monitoring system⁵⁾ also play a role in cutting consumption.

New: 2nd generation Euro VI engines: OM 470 and OM 471. With the thoroughly revised 10.7 l and 12.8 l units, the range now features two more fuel-saving engines, each of which is available in five power output ratings. In addition

to the X-Pulse enhanced common-rail high-pressure injection technology with an injection pressure of up to 2700 bar, the asymmetrical turbocharger and the optimised exhaust gas recirculation, new piston geometry and the optimised cooling system also contribute to the fuel savings. What's more, the significantly increased maximum torque allows the use of a higher rear axle ratio which, together with Predictive Powertrain Control, contributes to the low fuel consumption. In conjunction with the optimised powertrain and the ancillaries, the OM 470 and OM 471 can achieve fuel savings of up to 5% and 6% respectively, compared with the predecessor model.

¹⁾ Standard in conjunction with secondary water retarder.

²⁾ Depending on engine variant.

³⁾ Not for OM 936 engine.

⁴⁾ Standard for cabs with level floor and 170 mm engine tunnel, not available for 320 mm engine tunnel.

⁵⁾ Optional equipment.



Sophisticated aerodynamics. When designing the Actros we tested every individual part extensively. In the wind tunnel and over many millions of test kilometres – for extremely low wind resistance and low fuel consumption.



Tyre pressure monitoring system⁵⁾. Wireless pressure monitoring permanently monitors the tyre pressure and shows the current specified pressure required for the current tyre temperature on the basis of the outside temperature.

i Advantages at a glance.

- Up to 5% lower fuel consumption with Euro VI compared with predecessor model with Euro V
- 2nd generation Euro VI engines: OM 470 10.7 l and 12.8 l OM 471 with a higher rear axle ratio for fuel savings of up to 5% (OM 470) and 6% (OM 471) compared with the first generation
- Driving programs “economy” and “fleet” to reduce fuel consumption
- Fuel-efficient auxiliary consumers
- Sophisticated aerodynamics
- Tyre pressure monitoring system⁵⁾



Predictive Powertrain Control¹⁾: it knows your route. From start to finish. And provides for additional diesel savings of up to 5%.

Predictive Powertrain Control¹⁾ allows you to operate even more economically. Because the system always knows the route ahead. As a result, it can achieve fuel savings of up to 5% on motorways and highways covered by PPC in Western and Eastern Europe.

Predictive Powertrain Control¹⁾. The system integrates a driving style optimised for the route topography into the operation of the automatic transmission and, in conjunction with the precisely coordinated shift strategy, allows fuel savings of up to 5% to be achieved. Using satellite-based positioning technology and maps, Predictive Powertrain Control¹⁾ (PPC) identifies the course of the road and any downhill and uphill stretches ahead. The data provides the basis for the optimisation of the shift points, gear steps and the set cruise control speed. The kinetic energy of the vehicle is used as far as possible to avoid unnecessary acceleration, shifting or braking. PPC knows some 295,000 kilometres (95%) of European trunk roads and can be used at speeds between 25 and 90 km/h.



Topography-oriented driving style. Predictive Powertrain Control¹⁾ uses digital 3D road maps and GPS information to generate an electronic horizon which is employed to optimise shift points, gear selection and the set cruise control speed in anticipatory mode. In this way, a driving style adapted to the given topography which will generally be beyond the capabilities even of experienced drivers can be integrated into the automated system, resulting in additional fuel savings of up to 5%.



Driving situation: steep uphill gradient. In order to avoid shifting on an incline as far as possible, PPC performs the shift – if beneficial – before the start of the climb and/or increases the speed within the upper limit of the hysteresis range. Predictive Powertrain Control¹⁾ additionally provides for an optimised shift sequence, e.g. fewer gear changes and larger gear steps.

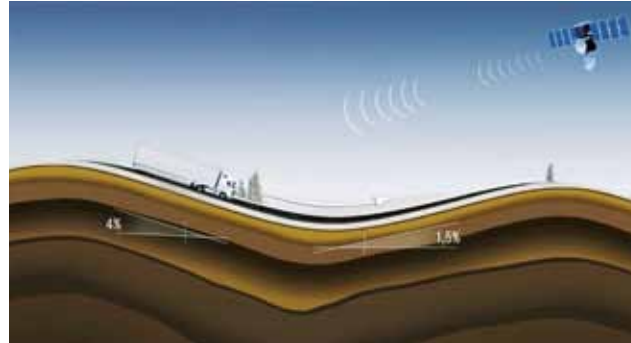

Driving situation: coasting. Why accelerate when coasting is sufficient? The kinetic energy of the vehicle is continuously determined. In other words: the vehicle automatically detects if it can attain the set cruise control speed quickly enough by coasting. What's more, EcoRoll can be used to avoid engine drag losses.

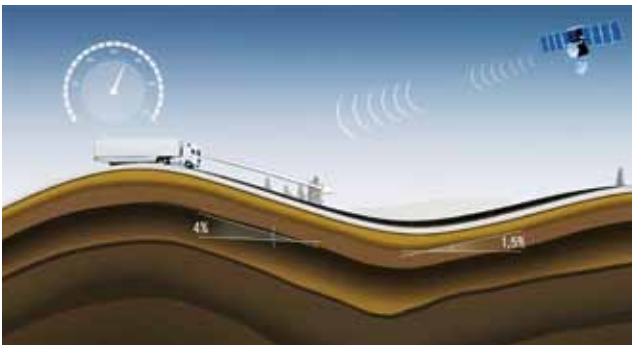

Driving situation: brow of a hill. The principle centres on coasting over the brows of hills to avoid braking on downhill stretches. The kinetic energy of the vehicle is continuously determined. This enables the vehicle to assess in good time whether it can coast over the brow of the hill at adequate speed. EcoRoll can be used to reduce engine drag losses.

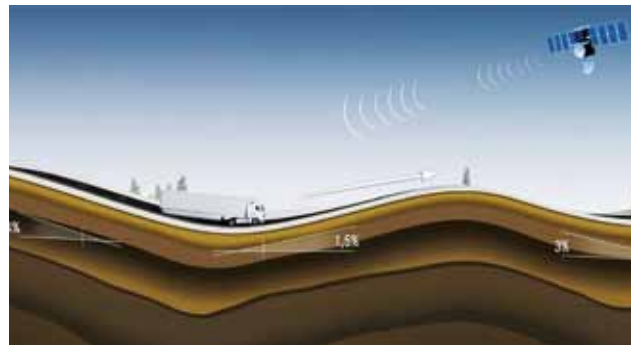

Driving situation: EcoRoll. As a result of precise activation, Predictive Powertrain Control¹⁾ is able to make optimum use of EcoRoll phases. This means that EcoRoll saves fuel not only on virtually level stretches, but also ahead of hilltops, for example. In addition, EcoRoll phases of under 10 seconds can be avoided in valleys, for example.



Advantages at a glance.

- Predictive Powertrain Control¹⁾: Fuel consumption reduced by as much as 5% thanks to a driving style that adapts to the topography of the road ahead
- Detection of the course of the road, e.g. uphill and downhill gradients ahead
- Optimisation of shift points, gear selection and the cruise-control speed setting
- Optimum use of the system via traffic-dependent setting with adjustable upper and lower hysteresis
- Available across Europe on motorways and trunk roads with PPC coverage

¹⁾ Optional equipment.



FleetBoard: Greater efficiency through enhanced transparency.

FleetBoard offers individualised telematics solutions for freight forwarders and logistics companies. The intelligent networking of the driver, fleet and job order provides you with valuable information. This helps you to reduce your costs while simultaneously increasing productivity and offering enhanced reliability.

FleetBoard. These are telematics-based internet services which are central to leading-edge vehicle, fleet and order management and which can enhance the cost-effectiveness of your fleet in various ways. They are based on the FleetBoard TiiRec hardware which is installed in the Actros as standard.

FleetBoard Order Management¹⁾. Designed to be integrated flexibly in a company's own dispatching and ERP system, FleetBoard Order Management stands for greater efficiency in logistics processes. DispoPilot.guide or DispoPilot.mobile supports efficient communications, transparent processes and the easy exchange of information between driver and headquarters.



FleetBoard Cockpit¹⁾. FleetBoard Cockpit brings together all the driver, fleet and order management services through its consistent and intuitive user interface. As a result of the linking of the individual services with each other, a dispatcher is not only able to know where a truck is but can also see on the map if the driver is currently on the road, taking a break or has already finished work for the day.

FleetBoard Time Management¹⁾. FleetBoard Time Management ensures that you can always keep track of your drivers' driving time and rest periods – an ideal basis for optimal resource and trip planning. Furthermore, you comply with all the statutory regulations regarding the archiving of driving times and rest periods – in fact, this practically takes care of itself. This saves money and reduces administrative effort.

FleetBoard Fleet.app. With the FleetBoard Fleet.app²⁾ for iPhone® and iPad® as well as for Android devices you are kept informed wherever you may be about whether the journeys are running according to schedule or if measures need to be taken at short notice – including at night in case of emergency.



FleetBoard TiiRec⁴⁾. The FleetBoard TiiRec vehicle computer serves as the basis for the various FleetBoard services which enhance efficiency and is installed in the Actros as standard.

FleetBoard DispoPilot.app³⁾. The new Android-based app allows logistics processes and capacities to be configured flexibly and dynamically – through the integration of subcontractors in your transport processes, for example.

FleetBoard Driver.app³⁾. The Android-based app designed specifically for the driver enables direct access to the driver's own data from the FleetBoard Performance Analysis and Time Management services. This provides drivers with an overview of their style of driving and their current driving times and breaks. The Fitness Coach and the Messenger are great features to keep the driver occupied during breaks and after work.



DispoPilot.guide. The quick and easy way to your destination: once the job data have been transmitted, information such as the loading and unloading address can be transferred directly to the integrated navigation system.

More information. Details of further advantages of FleetBoard are also available at www.fleetboard.com or direct from your authorised Mercedes-Benz Dealer.

¹⁾ Optional equipment

²⁾ Available free of charge from the App Store and the Google Play Store.

³⁾ Available free of charge from the Google Play Store.

⁴⁾ Standard for the Actros.

Performance Analysis³⁾. FleetBoard Performance Analysis contributes to a driving style which is conducive to reducing fuel consumption and wear. To this end, the telematics system records and analyses technical data from the truck. Furthermore, the system indicates how intensively the Predictive Powertrain Control system is being used. The driver's style of driving is assessed on the basis of these data and a corresponding mark is awarded. This enables an objective assessment of the driving style and allows the training to be tailored to the individual driver. FleetBoard Performance Analysis together with FleetBoard EcoSupport¹⁾ also ensures that the driver retains on a lasting basis the fuel-efficient driving style acquired in Mercedes-Benz EcoTraining, for example. Overall, long-term fuel savings of up to 15% can be achieved in this way.

FleetBoard EcoSupport²⁾. The system assists the driver in a fuel-saving driving style. To this end it displays tips while on the road that provide an opportunity to further optimise the individual driving style and reduce fuel consumption.

EcoTraining³⁾. Mercedes-Benz EcoTraining teaches a way of driving that allows you to make even better use of the technical potential of your truck for even further fuel savings.

This is based on the evaluation of the data from the FleetBoard driving analysis.

FleetBoard Drivers' League. A contest where drivers can demonstrate their skills. Where saving fuel is fun and is rewarded twice over. Your drivers can win attractive prizes and you reduce your costs. See www.driversleague.com for further information and registration.



¹⁾ Independent of the FleetBoard telematics system.

²⁾ Standard for the Actros.

³⁾ Optional equipment

⁴⁾ Available free of charge from the App Store and the Google Play Store.

⁵⁾ Available free of charge from the Google Play Store.



i Advantages at a glance.

- FleetBoard TiiRec²⁾ vehicle computer
- FleetBoard Order Management³⁾ for efficient logistics processes
- FleetBoard Time Management³⁾ for optimal resource and trip planning as well as easy compliance with statutory regulations and reduction of the documentation workload
- FleetBoard Fleet.app⁴⁾ for mobile access to the fleet
- FleetBoard DispoPilot.app⁵⁾ for the flexible organisation of transport capacities
- FleetBoard Driver.app⁵⁾ for drivers
- Plus: fuel savings of up to 15% through FleetBoard Performance Analysis³⁾, FleetBoard EcoSupport and Mercedes-Benz EcoTraining³⁾
- FleetBoard Drivers' League as additional motivation for a fuel-saving driving style



Financing your vehicle:

with Mercedes-Benz Finance.

Our customised financial services make your accounting more flexible. Together with Mercedes-Benz Finance and our Mercedes-Benz Dealers, we are able to tailor our products to suit your needs. One of the best things about using Mercedes-Benz Finance to fund your truck is that you gain not just the best truck on the market, but you also have a new business partner who will be with you every step of the way.

Mercedes-Benz Finance was established in the UK more than 25 years ago and has over 215,000 finance agreements. They are the only finance partner who has our full backing and they only finance Mercedes-Benz products. All of this means that no-one else can provide you with more in-depth product support and assistance whenever you need it. Their experienced Business Managers will work with you to understand your business needs and will provide you with a business solution when funding your vehicles. In the meantime the next page will give an overview of all their finance products.



Hire Purchase is a straightforward, affordable route to ownership. This is the perfect way to buy a vehicle if you want to work your way up to full ownership over a period of time and spread the overall cost of owning a Mercedes-Benz.

Agility, our Contract Purchase Product, is a flexible method of financing a truck over a fixed term which allows you to defer your decision to purchase, hand back or part-exchange your vehicle until the end of your agreement.

Operating Lease gives you the ability to enjoy driving a Mercedes-Benz without having to take on full ownership. With this option you lease your vehicle for a fixed period and for a fixed monthly rental. It requires no capital investment and the vehicle is not shown on your balance sheet.

Contract Hire is an Operating Lease agreement that is combined with a service, repair and maintenance package as well as the cost of your vehicle's Road Fund Licence for the duration of your agreement.

Finance Lease allows your vehicle to appear as an asset on your balance sheet without the option of ownership, as you hire a vehicle for a fixed period.

To find out more about Mercedes-Benz Finance visit:

mbtrucks.co.uk/finance

To find out more about our latest offers visit:

mbtrucks.co.uk/offers



i Investment (3) – advantages at a glance

- Tailored finance packages to suit your needs
- It is possible to design a bespoke repayment pattern that matches your business's income and expenditure cycles
- Service Contracts are available on all our finance products

Lower costs, higher efficiency. For repairs and maintenance, too.

We do everything to keep repair and maintenance costs as low as possible for you. For example, with a design that is optimised to make repairs particularly easy, with fixed price packages and Mercedes-Benz service contracts.

High cost-effectiveness. From the very start, the Actros was designed with a view to keeping costs particularly low – both in everyday use and with regard to maintenance and repairs. Furthermore, additional cost savings are possible with Service Contracts, for example.

Ease of repair. The introduction of the new Euro VI emissions standard brought with it considerable additional technical sophistication. There are many reasons why our trucks can nevertheless be repaired and maintained as inexpensively as comparable predecessor models. Right back at the design stage, care was taken to ensure that all the components are not only particularly robust but can also be replaced or repaired particularly quickly and cost-effectively if necessary. For lower costs and higher efficiency.

Mercedes-Benz Genuine Remanufactured Parts As a cost-effective and environmentally friendly alternative, the extensive portfolio of remanufactured parts offers the usual high quality of Mercedes-Benz and tested safety at attractive prices. This is because the savings in terms of resources and energy which did not have to be expended to produce new genuine parts are passed on to you in the form of reduced prices.

Fixed price packages. With our fixed-price packages, you know in advance what costs will be incurred and how long the maintenance or repair will take. As a result, you can plan with certainty with regard to costs and vehicle availability.

Mercedes-Benz GenuineParts. High quality at an affordable price as a basis for value retention and overall economy. The extensive range of parts, efficient logistics and quick availability are further advantages.



Mercedes-Benz service contracts. From warranty extensions to maintenance packages to a comprehensive service package including wear items – the Mercedes-Benz graduated range of service contracts offers flexible repair and maintenance products which are geared to customers' requirements and which allow them to plan monthly costs and make optimal use of their fleet capacity:



Advantages at a glance.

- Service-oriented design for lower repair and maintenance costs
- Mercedes-Benz GenuineParts for high reliability and value retention as well as Genuine Remanufactured Parts as a cost-effective alternative
- Fixed-price packages offer the soundest basis for reliable cost planning
- Mercedes-Benz service contracts for monthly instalment planning as well as increased vehicle availability:
- Service24h fast emergency assistance is available around the clock via the free service hotline on 00800 5 777 7777



The greater the residual value, the greater the cost-effectiveness. It's as simple as that.

When you choose one of our trucks, you can count on being able to operate particularly economically. This is because the high residual value you can expect reduces the operating costs throughout the entire period of use. At the same time, you are laying the foundations for the future. Because a first-rate truck is an investment in the next truck.

Residual value. When you choose our trucks, you can count on vehicles whose innovative technology and task-optimised vehicle configurations mean you can look forward to a particularly high residual value. This is an important consideration for every truck operator, because the higher a truck's residual value is at the end of its period of use, the lower its depreciation is while it is in service.

Approved Used Commercial Vehicles. We have the largest selection of Mercedes-Benz Used Commercial Vehicles in the UK, available from 60 Dealer locations and supported by more than 90 Dealer service departments. Only our premium quality trucks qualify to be one of our Approved Trucks.



Finance. In order to know how much you can expect to receive for your truck upon disposal, its residual value can if you wish, be guaranteed either directly through Mercedes-Benz UK or via a suitable Mercedes-Benz Finance product, with all agreed prior to delivery of your new truck. With a confirmed value for the future, this provides you with a sound basis on which to plan the allocation of your capital resources and also with consideration for the investment in your next truck.

Peace of mind with Mercedes-Benz Repair & Maintenance. For peace of mind over your running costs, why not take out one of our Repair & Maintenance Contracts, which are available on our full range of used trucks and include 24hr Service and Aftersales Support from over 90 UK Dealer locations.

Mechanical Breakdown Insurance. Benefit from an impressive range of products and services and first-class advice: with the finance packages offered by Approved Used Commercial Vehicles we think we can supply the used commercial vehicle you're looking for. Choose between classic financing and leasing arrangements or numerous individual variants and so reduce your capital commitment.



Advantages at a glance.

- Approved Used Commercial Vehicles – professional used vehicle organisation for purchase and sale of used trucks of all brands, age groups and versions
- To provide certainty on the future value, and so that you know what resale value to incorporate into any whole-life cost calculation, we can – if you wish – guarantee the residual value to you either directly through Mercedes-Benz UK or via a suitable Mercedes-Benz Finance product
- A calculable factor for the future
- No risk to trade-in value at end of contract
- Comprehensive services such as leasing and financing



We do everything. For a particularly high level of safety.

Reaching the destination safely – with the support of assistance and safety systems which actively ease the burden on the driver, help protect the vehicle and its cargo and so contribute to greater cost-effectiveness. On every trip.

Safety equipment. Mercedes-Benz employs many safety and assistance systems to reduce risks and ease the burden on the driver. Alongside the Electronic Braking System with ABS, ASR, Brake Assist, hill holder and Active Brake Assist, the Stability Control Assist system, Lane Keeping Assist and Attention Assist also contribute to the high level of safety. Systems such as the bi-xenon headlamps¹⁾, the rain/light sensor¹⁾, the co-driver mirror with a manoeuvring function¹⁾ and the tyre pressure monitoring system¹⁾ help the driver to avoid or mitigate accidents.

Active Brake Assist. Fitted as a statutory requirement and operating within the system limits, Active Brake Assist can detect obstacles driving ahead of the vehicle, warn the driver of dangers identified and, if necessary, carry out a full brake application to mitigate the severity of a possible accident and its consequences.

Safety Packs. Driver and Safety Packs¹⁾ increase comfort and safety, and offer increased cost effectiveness.



Proximity Control Assist²⁾. The safety system with stop-and-go function is on hand to support the driver in stressful situations and can reduce the risk of rear-end collisions.



Attention Assist³⁾. The system can recognise increasing tiredness and recommend the driver takes a break.



Sensor-controlled fifth-wheel coupling. The sensor-controlled fifth-wheel coupling¹⁾ notifies the driver via a display in the instrument cluster whether the fifth-wheel coupling is open or closed. This increases safety and saves on repair costs.



Secondary water retarder. The secondary water retarder^{1) 8)} is wear- and maintenance-free and offers increased brake power, higher average speeds on downhill stretches and less weight than conventional oil retarders.

- ¹⁾ Optional equipment.
- ²⁾ Optional extra, only in conjunction with Active Brake Assist 3 or Active Brake Assist 4.
- ³⁾ Only available in conjunction with Lane Keeping Assist.
- ⁴⁾ Optional equipment, only in conjunction with Proximity Control Assist.
- ⁵⁾ Expected to be available from 02/2017.
- ⁶⁾ Within the system's limits.
- ⁷⁾ Under optimal conditions.
- ⁸⁾ Available in conjunction with High Performance Engine Brake.



Active Brake Assist 4^{4) 5)}. The fourth generation of the system assists the driver^{6) 7)} by carrying out a full brake application in response to stationary and moving objects and partial braking in response to pedestrians in motion; in this way, it can reduce the severity of accidents or even prevent them completely.



Bi-xenon headlamps¹⁾. Both the dipped and main beam headlights benefit from the particularly high light output of the bi-xenon lamps which also use less energy than the standard headlights.

i Advantages at a glance.

- Comprehensive scope of standard equipment, incl. Active Brake Assist, Stability Control Assist, Lane Keeping Assist, Attention Assist and follow-me-home lighting
- Proximity Control Assist²⁾ with stop-and-go-function and Active Brake Assist 4^{4) 5)}
- Secondary water retarder¹⁾ with up to 3500 Nm of braking torque
- Tyre pressure monitoring system¹⁾ for tractor unit and semitrailer/trailer
- Sensor-controlled fifth-wheel coupling¹⁾
- Co-driver's mirror with manoeuvring function¹⁾
- Safety Packs¹⁾
- Bi-xenon headlamps¹⁾, cornering light function¹⁾, front fog lamps¹⁾ and LED daytime running lamps¹⁾



We do everything. To ensure particularly high vehicle availability.

For short downtime and permanent operational effectiveness: for example, with our extensive European network of workshops with extended opening hours; Mercedes-Benz Service Complete and Service24h for fast assistance in an emergency.

Mercedes-Benz Service. Throughout Europe some 1800 Mercedes-Benz service outlets are at your disposal for workshop services, some even open 24 hours. Furthermore, our trained staff and an extremely efficient parts logistics system enable particularly short repair times and ensure that your Actros is back on the road as quickly as possible.

Maintenance. The information displayed in the cockpit provides you with advance warning about when your vehicle's next maintenance visit is due. This is determined on the basis of the continuous evaluation of data about the actual workload of the vehicle: for example, every single cold start, the degree of brake pad wear, the condition of the engine oil and all major assembly oils. In this way, maintenance can be planned anticipatively and can be combined with statutory inspections, for example. This avoids additional downtime.

Extended opening hours. Some of the roughly 1800 Mercedes-Benz service outlets throughout Europe are even open for 24 hours. This makes maintenance planning easier and more flexible. What's more: even more major repairs can be carried out within one working day – so that your vehicle is not at the workshop any longer than absolutely necessary.



Mercedes-Benz Service Complete. Service Contracts can cover all contingencies to your best advantage. They can provide cover for all vehicle components and assemblies as well as the replacement, repair and maintenance of all wear parts for precisely calculable, attractive monthly instalments. Furthermore, Service Complete can be extended optionally to include international coverage (Europe). This means that downtime days can be used for planned repairs and maintenance also when abroad, with improved vehicle capacity utilisation as a result.

Mercedes-Benz Service24h: assistance around the clock. Mercedes-Benz Service24h ensures direct assistance in the event of a breakdown – 365 days a year and 24 hours a day. A call to the free¹⁾ hotline on 00800 5 777 7777 is all it takes. Qualified staff assist the caller in his or her own language and arrange for assistance to be provided quickly by the nearest Mercedes-Benz truck workshop. In the event of a breakdown,

optimally equipped service engineers in mobile workshops are deployed and, in four cases out of five, are able to remedy the problem on the spot so that the vehicle can resume its run as quickly as possible.

Looking ahead. Mercedes-Benz never stops working on solutions which increase the efficiency and thus also the availability of your truck.

¹⁾ If your mobile phone provider charges for Freephone numbers, please call +44 (0) 207 660 9991.

²⁾ Please first notify the police and rescue services if any person is injured.



Advantages at a glance.

- Extensive workshop network with around 1800 service outlets throughout Europe
- Long workshop opening hours, in some cases for 24 hours
- Maintenance system for anticipative maintenance planning and short downtime
- Mercedes-Benz Service Complete for monthly instalment planning as well as increased vehicle availability
- Service24h: fast emergency assistance²⁾ is available around the clock via the free¹⁾ service hotline on 00800 5 777 7777





Impressive driving dynamics: the easy way to make every job more effortless and less stressful.

Precisely tuned powertrain configurations, immediate power delivery, high driving stability, precise steering characteristics and, last but not least, numerous assistance and safety systems – all of this noticeably eases the burden on drivers, giving them a unique driving experience. In short, hardly any other truck is able to offer such a safe, superior and relaxing drive as the Actros.

Dynamic handling. The Actros is characterised by outstanding driving dynamics delivered by the perfect interplay of all the drive system, chassis and suspension components. For example, the precise response of the high-torque in-line engines and the perfectly matched shift strategy of the Mercedes PowerShift 3 automated transmission deliver an immediate, comfortable response when moving off. What's more, the power generated in the engine is put down on the road particularly efficiently thanks to the hypoid rear axle. This makes for optimum suitability for operating profiles, low fuel consumption and thus greater economy.

When it comes to ride comfort, too, everything is perfectly coordinated: from the sensitive steering system to the frame and the 4-bellows air suspension to the innovative rear axle guide¹⁾.

It all adds up to: maximum driving comfort and a particularly effortless and relaxing driving experience. From start to finish.



¹⁾ Only for 4x2 vehicles, not for Actros Loader.

Innovative rear axle guide. The innovative rear axle guide¹⁾ stands for high transverse stability, low roll movements, reduced need for corrective steering and very good understeer/oversteer characteristics.

Driving pleasure and cost efficiency in one.

Pulls away immediately and effortlessly with high power delivery that you can feel straight away – all the powertrain components of the Actros are perfectly tuned to each other. For highly economical operation and exceptional driving dynamics.

Mercedes PowerShift 3. Superior dynamic response, simple handling and low fuel consumption: the automated transmission ensures precise gear selection, short shift times, high driving comfort and optimal economy. The “economy” driving mode supports a particularly economical driving style, the “power” mode a very dynamic one. The fleet driving program is pre-set to use “fleet” driving mode. Mercedes PowerShift 3 provides fast shifting from forward to reverse and high-ratio reverse gears for easy manoeuvring. Moving off is noticeably more comfortable thanks to the crawl function.

Driving program	fleet			
		power		
	economy			
Transmission mode	economy	standard	manual	power
	No kickdown possible	Kickdown possible	No kickdown possible	Kickdown possible
	EcoRoll cannot be switched off	EcoRoll can be switched off	EcoRoll can be switched off	EcoRoll deactivated
	Top speed ¹⁾ 85 km/h	Top speed 89.8 km/h	Top speed 89.8 km/h	Top speed 89.8 km/h

Actros driving programs. The Actros is available with the three driving programs, fleet, economy or power, one of which can be selected at the time of purchase. Different driving modes increase driving comfort and efficiency.



Additional functions. With Mercedes PowerShift 3, additional functions, such as direct shifting from forward to reverse as well as high-ratio reverse gears make for easy manoeuvring. Moving off is extremely comfortable thanks to the crawl function.



EcoRoll mode. Selective use of EcoRoll mode allows the Actros to operate even more fuel-efficiently by spending longer coasting on the level and also ahead of hilltops and at the end of hill sections.



Economy driving program. This driving program can be activated selectively and supports a particularly economical driving style.



Hypoid rear axle. The rear axle is a weight-optimised sheet-steel formed axle with a 440 mm ring gear. It is fitted to air-suspended 3-axle vehicles up to a gross train weight of 80 t. It has a single ratio. The hypoid toothing ensures high running smoothness with low frictional losses. The drive shafts have maintenance-free compact bearings; the wheel bearings are also maintenance-free.



Advantages at a glance.

- Exceptional driving dynamics through perfectly tuned powertrain configurations and immediately responsive engines
- Mercedes PowerShift 3 automated transmission with selectively engageable drive modes and additional functions matched to operating profiles
- Precise gear selection in accordance with the particular driving situation in question
- Friction-loss-reduced hypoid rear axle
- Comprehensive range of rear axle ratios and transmission variants

¹⁾ Top speed of 89.8 km/h possible using the accelerator.



Outstanding handling. For an outstanding driving experience.

Frame, chassis, suspension and steering – in the Actros all the elements unite to form a perfect whole. For an outstandingly capable, safe and relaxed driving experience.

Actros handling. The Actros has excellent roadholding and an outstandingly capable, safe driving feel: factors responsible for this include the wide, rigid frame, the innovative rear axle guide¹⁾ and the direct, sensitive steering system.

Suspension components. All the suspension elements in the Actros are precisely tuned to one another: from the seats to the cab mountings available in three variants to the 4-bellows air suspension at the rear axle – the overall result is a high degree of suspension comfort for the workplace and a ride which helps protect both the vehicle and its cargo.



Precise steering. The direct and particularly sensitive steering has speed-sensitive power assistance. This makes manoeuvring particularly straightforward, effortless and safe. And at high speeds the system supports reliable straight-ahead running and the best possible directional stability. A high level of steering accuracy and very good understeer/oversteer characteristics are further advantages which contribute to more safety and outstanding capability.

Rear axle guide. The innovative rear axle guide¹⁾ also plays a decisive role in the excellent handling: Compared with a conventional wishbone, the connection points of the two trailing arms are positioned further towards the outside. This results in the best possible transverse stability, little need for corrective steering and very good understeer/oversteer characteristics.



Air suspension. The air suspension bellows on the 4-bellows air suspension have been attached on the far outside, and in conjunction with the innovative rear axle guide¹⁾ ensure excellent roll characteristics and a small roll angle in bends.



Frame. The frame of the Actros is uncompromisingly geared to use in long-distance transport. The 834 mm wide track and the rigid design ensure good roadholding and comfortable handling. Other advantages include the 50 mm matrix of pre-drilled holes throughout as well as a large range of wheelbases, frame overhangs and end cross members.



Advantages at a glance.

- Comfortable, safe handling and a superior driving experience
- Suspension elements for seats, cab mountings and chassis suspension all optimally tuned with each other
- Direct steering with sensitive response for high steering precision
- Innovative rear axle guide¹⁾ for high transverse stability and very good understeer/oversteer characteristics
- 4-bellows air suspension for very good roll characteristics and a small roll angle
- Rigid frame with wide track for excellent roadholding
- High degree of body-mounting ability thanks to wide range of wheelbases, frame overhangs and end cross members

¹⁾ Only for 4x2 vehicles, not for Actros Loader.





Simply load more on. The Actros Loader and the Actros Volumer.

Giving you a greater payload and volume: In the Actros Loader and Actros Volumer you have two specialists at your disposal that can simply transport more.

Sector-specific vehicle concepts. The Actros meets the need for an extremely cost-effective solution to the challenges of long-distance transport. To respond to this requirement all the more effectively in the payload-sensitive and high-volume transport segments, we have developed the Actros Loader and the Actros Volumer. Because specialised tasks call for specialised tools – or rather, specialised vehicles.

The Actros Loader payload-optimised tractor units and rigids are among the lightest in the long-distance haulage sector. With high-performance, economical Euro VI engines, cabs matched to the jobs they have to do – and without taking anything away from the high safety standards of the Actros.

Similarly, the Actros Volumer offers users the opportunity to operate more cost-effectively in the high-volume haulage sector. This high-volume haulage specialist includes features such as a coupling point height of less than 900 mm, to meet the exacting requirements placed on 4x2 tractor units. In practice, this means a clear loading height of 3 m. In addition to the large cargo volume, particularly efficient powertrain configurations and factors such as the huge fuel tank capacity contribute to the enhanced cost-effectiveness. Application-oriented cab variants such as the CompactSpace, which is particularly well-suited to car transportation, also play their part.

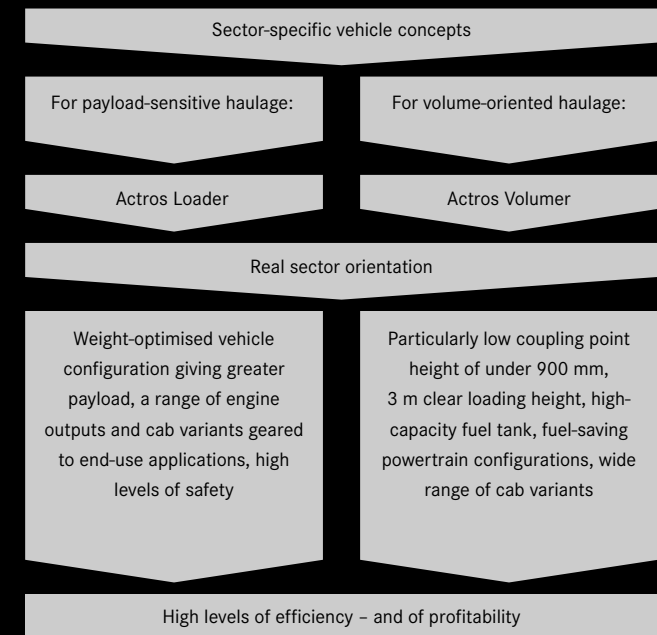

Specialists. With its Actros Loader and Actros Volumer models, Mercedes-Benz offers application-optimised vehicle configurations which simply allow you to run payload and volume-oriented transport operations more profitably.

The Actros Loader: for those who want more payload.

A lower net weight for a heavier payload – from the radiator grille to the end cross-member. The Actros Loader has been specifically designed to meet the requirements of payload-sensitive sectors. This is why it is among the lightest vehicles in long-distance transport. Regardless of whether as a tractor unit or rigid. Quite simply, you can pack more onto the Actros Loader. And that pays off. On every trip.

Loader concept. Greater payload, greater economy. The name Actros Loader stands for payload-optimised tractor units and rigid vehicles which, despite the more weight-intensive Euro VI technology, are considerably lighter than the proven Euro V Actros. Thanks to a whole series of large and small weight-reducing measures, you can simply carry a greater payload on every trip. For maximum flexibility at the vehicle configuration stage, you can also choose not to have certain weight-reduction measures implemented. In this way, you can opt for greater comfort, for example, rather than lower fuel consumption.

Payload optimisation ex factory. Designed especially for payload-sensitive haulage applications, the Actros Loader tractor unit with a ClassicSpace cab features a 320 mm high engine tunnel, light engines from the 7.7 l displacement class and an output of **235 kW** (320 hp)¹⁾. Standard equipment includes Mercedes PowerShift 3 with a 12-speed direct-drive transmission as well as weight-saving super-wide tyres on aluminium rims.

Cabs. The Actros Loader can be equipped with the ClassicSpace L-cab with 170 mm or 320 mm engine tunnel. For lower fuel consumption with taller trailers, two aerodynamically refined StreamSpace cabs are also available.



Cab sidewall without locker door. Less unladen weight, more payload. The closed cab wall on the right-hand side results in a weight saving of five kilograms.

Engines. Actros Loader tractor units are equipped with Euro VI engines in the 7.7 l displacement class with outputs from **235 kW** (320 hp). The rigids in this displacement class are available with a choice of five power output ratings from **175 kW** (238 hp) to **260 kW** (354 hp). The Actros Loader can also be equipped with engines in the 10.7 l displacement class which are available with five power output ratings from **240 kW** (326 hp) to **335 kW** (455 hp).

Safety equipment. The Actros Loader is available with the full spectrum of safety and assistance systems – either singly or bundled in appropriate and reasonably priced Safety Packs²⁾. See page 40 for further information.



i Advantages at a glance.

- Extremely high payload through application-oriented vehicle configurations and weight-reducing measures
- Weight-saving equipment features; deselection of certain items possible
- Light, economical Euro VI in-line engines with a displacement of 7.7 or 10.7 l with ten power output ratings from 175 kW (238 hp) to 335 kW (455 hp)
- Four cab variants
- High level of safety through availability of all safety and assistance systems
- Safety Packs²⁾

Weight-reduction measures. Many components and equipment features of the Actros Loader are systematically designed for use in the payload-sensitive sectors. But because we know that payload is not “everything”, you can also deselect various payload optimisation elements – for greater comfort, for example, rather than lower fuel consumption.

¹⁾ Actros Loader rigids: from 175 kW (238 hp).

²⁾ Optional equipment.

³⁾ Illustration shows separate diesel/AdBlue[®] tank as an example.



The Actros Volumer: for those who need lots of space.

Huge transportation volumes, fuel-saving powertrain configurations, a long operating range and perfect alignment to the application for which you intend to deploy it – the Actros Volumer shows how tractor units and rigids need to be built today, to make high-volume haulage especially profitable.

Volumer concept. As a true high-volume haulage specialist, the Actros Volumer allows you to make optimal use of the maximum transportation volume in the long-distance transport sector. In conjunction with 315/45 tyres and the lowered ride height, a coupling point height of under 900 mm and a resultant clear loading height of 3 m are possible. This allows three standard automotive pallets to be stacked on top of each other easily, for example. Other advantages include fuel-saving powertrain configurations and a wide choice of tank variants for low consumption and a particularly long operating range.

Cabs. The Actros Volumer is available with a total of eleven cab variants which meet practically all the requirements in international and national high-volume haulage. The choice ranges from the GigaSpace cab down to the CompactSpace cab which is optimal for car transportation.

Drive system. The application-optimised powertrain configurations also make the Actros Volumer an economical transport solution – as the wide range of rear axle ratios available means that the Actros Volumer can also be equipped with a direct-drive transmission in conjunction with 315/45 tyres. And that saves up to 1% fuel compared with an overdrive transmission.

Engines. The economical 6-cylinder in-line engines of the Actros Volumer are available in the three displacement classes 7.7 l, 10.7 l and 12.8 l and therefore in a total of 15 power output ratings from **175 kW** (238 hp) to **390 kW¹⁾** (530 hp).



Long operating range. With a fuel tank capacity of up to 990 l for tractor units and up to 1000 l for low-frame rigids, the Actros Volumer provides a particularly long operating range for high-volume haulage.

Tank capacity. Despite having Euro VI exhaust technology, which calls for more space, Actros Volumer tractor units can be equipped with a tank capacity of up to 900 litres. Low-frame rigids can even have a tank capacity of up to 1000 l. This makes for a long operating range and saves money by avoiding the need to retrofit add-on tanks.

- 1 Eleven application-oriented cab variants
- 2 Euro VI engines with 15 power output ratings
- 3 Fuel-saving powertrain configurations
- 4 Long range through wide choice of tank sizes
- 5 3 m clear headroom
- 6 Low frame/coupling point height



Advantages at a glance.

- Particularly low coupling point height for 4x2 tractor units
- Clear loading height up to 3 m
- Wide selection of final drive ratios
- Fuel-saving, task-oriented powertrain configurations for every tyre combination
- Large operating range thanks to tank capacity of up to 990 l for tractor units and up to 1000 l tank capacity for low-frame rigids
- Euro VI in-line engines with reduced fuel consumption in 15 power output ratings from 175 kW (238 hp) to 390 kW¹⁾ (530 hp)
- Total of eleven cab variants in widths of 2500 and 2300 mm: e.g. the CompactSpace cab for car transporters

Volumer details. With a particularly low coupling point height of under 900 mm, the Actros Volumer has what it takes to provide cost-effective high-volume transport services. The clear loading height of 3 m as well as the wide choice of cab variants, task-optimised powertrain configurations and tank variants play their role, too.

¹⁾ Only for 6x2 LnR.





Heavy haulage made easy. The Actros SLT – up to 250 tonnes.

The Actros SLT up to 250 tonnes. The Actros up to 250 tonnes is a tractor unit that has been systematically designed and built to move particularly heavy and large loads. What's more, The Actros SLT up to 250 tonnes sets standards for comfort, vehicle performance and flexibility. It excels at first glance, on every trip – and during breaks, too: with the GigaSpace and the BigSpace cabs it offers exactly the level of working and accommodation comfort that you need in the heavy haulage sector.

With its powerful, reliable Euro VI engines, the Mercedes PowerShift 3 automated transmission and the turbo retarder clutch, it has a powerful, extremely resilient drive which delivers precisely the performance required to cope with the challenges of heavy haulage. To ensure that you can always make the most of the huge engine output, we have equipped the Actros up to 250 tonnes with a particularly robust chassis, suspension and frame which puts the power delivered down on the road precisely, even when the truck is operating at full capacity.

The huge and varied range of equipment and models ensure maximum flexibility and the best match for the end-use application, resulting in a perfectly-configured vehicle for practically every type of deployment. Making light work of heavy-duty transport. The Actros SLT up to 250 tonnes.



Centre of power. The 6-cylinder in-line engines of the Actros SLT meet the performance requirements in the heavy haulage sector. The durability and reliability of the design are further advantages of the Euro VI engines.

The Actros SLT. Concentrated technology at a glance.



- 1** Compressed air tanks¹⁾
High air capacity to meet operational requirements with heavy multi-axle trailer combinations
- 2** Fuel tank¹⁾
900 l aluminium tank for maximum range
- 3** Rear-mounted cooling system¹⁾
Integrated cooling system for optimal cooling when under power and during retarder operation at the highest weights or in hilly terrain
- 4** Euro VI exhaust system
- 5** Leading axle¹⁾
8 t air-suspended, hydraulically steered
- 6** Heavy-duty trailer coupling at rear¹⁾
Mounted on heavy-duty crossmember. Side-mounted trailer connections

¹⁾ Optional equipment.

- 7** Pressure plate for semi-trailer¹⁾
Prevents damage to frame and end cross-member
- 8** Range of 3.5" fifth wheel couplings, fixed or sliding¹⁾
For individual adjustment of total combination length and optimal axle load distribution
- 9** Steps and catwalk
For convenient and safe access to the vehicle frame

- 10** Side panels with cooling air intakes
For an optimal flow of cooling air
- 11** Heavy-duty coupling at the front¹⁾
Reinforced trailer coupling bracket with height-adjustable coupling



Sustained high power transmission. The way it should be in the heavy haulage sector.

High power alone is not enough – it has to be delivered precisely where and, above all, when it is needed. The Actros SLT shows how it's done, for example with the Mercedes PowerShift 3 automated transmission, task-optimised driving programs, 16 gears and the Turbo Retarder Clutch.

SLT auxiliary cooling system. The additional cooling system¹⁾ ensures that the full output available from the engine can be used for an unlimited period. It also enables maximum deployment times for the integrated retarder. When alternating between traction and braking, in high exterior temperatures and at high altitudes, especially during heavily laden descents, the rear-mounted cooling system ensures that performance is maintained. The system is accommodated in the cooling tower behind the cab.

Turbo Retarder Clutch¹⁾. The new standard in heavy haulage – it delivers particularly high power for moving off while also enabling responsive manoeuvring at low revs and full torque for as long as is necessary. The wear-free Turbo Retarder Clutch combines the functions of a hydrodynamic start-up clutch and a primary retarder in a single component.



Mercedes PowerShift 3. The Actros SLT is equipped with the Mercedes PowerShift 3 automated transmission in conjunction with the Turbo Retarder Clutch and an optimally matched 16-speed constant-mesh transmission. Precise gear selection in accordance with the demands of the current driving situation is handled by the accompanying “heavy” shift program. The crawl function with the integral manoeuvring mode makes moving off easy and manoeuvring precise and responsive. Furthermore, there are various driving modes and additional functions to make driving a heavy haulage truck and load easier.

Transmission G 280-16 11.7-0.69. For particularly heavy-duty requirements, the Actros SLT up to 250 tonnes GCW is available with Mercedes PowerShift 3 and a 16-speed transmission¹⁾.

Heavy driving program²⁾. The driving program is specially designed for heavy haulage work. It impresses with particularly short shift times and precise gear selection matched to the current situation.

Power driving program²⁾. It comprises the driving modes “power”, “standard” and “manual”. “Power” is designed for on-road use in long-distance transport and supports the need for an extremely agile driving style.

¹⁾ Optional equipment.

²⁾ Alternative at no extra cost.

Driving program				heavy
	power			
Transmission mode	<p>power</p> <ul style="list-style-type: none"> For heavy loads while maintaining good fuel consumption figures <ul style="list-style-type: none"> Very short shift times Kickdown possible Time or torque-based automatic return to “standard” <ul style="list-style-type: none"> No EcoRoll 	<p>standard</p> <ul style="list-style-type: none"> For heavy loads with high-comfort shifting <ul style="list-style-type: none"> EcoRoll possible (activated/deactivated via menu) Kickdown possible EcoRoll only up to gross combination weight of approx. 80 t 	<p>manual</p> <ul style="list-style-type: none"> No kickdown No EcoRoll No automatic return to “standard” For highly specialised applications, the driver’s input can be implemented without any intervention by the automated transmission 	<p>heavy</p> <ul style="list-style-type: none"> For very heavy loads and demanding terrain Upshifts occur only once the appropriate engine speed has been attained Very short shift times Kickdown possible No automatic return to standard mode <ul style="list-style-type: none"> No EcoRoll

i Advantages at a glance.

- Rear cooling system¹⁾ for extended engine and retarder runtime
- Wear-free Turbo Retarder Clutch¹⁾ to handle extreme loads when moving off and manoeuvring
- Mercedes PowerShift 3 16-speed automated transmission¹⁾
- Short shift times, high performance
- Driving programs matched to the task as well as driving modes and additional functions
- Space-saving arrangement of the Euro VI emissions technology



Perfect framework conditions for flexible deployment.

Special transport calls for special vehicles. This is why the Actros SLT not only has a particularly robust and strong load-bearing standard specification, but can also be tailored optimally to your heavy haulage application.



Cross-member for heavy-duty coupling at the front. For particularly demanding heavy-duty work, the cross-member can be equipped to take the front heavy-duty coupling.

Height-adjustable coupling, front, 50 mm. The SLT tractor unit can be equipped with additional heavy-duty couplings for towing/pushing applications. This involves the front trailer coupling bracket being fitted with either a height-adjustable coupling or a heavy-duty coupling for towing and pushing applications.

SLT drawbar cross-member. The end cross-member¹⁾ allows a heavy-duty trailer coupling to be fitted. This extends the possible areas of use of the vehicle. The position of the reinforced end cross-member allows the G 150 trailer coupling to be fitted in the upper position or the 250 t heavy-duty trailer coupling to be fitted in the lower position.



Heavy-duty trailer coupling. The Rockinger 56 E heavy-duty trailer coupling is designed for loads up to 250 t. It can be fitted in two different positions on the heavy-duty cross member.

Pre-installation, heavy-haulage vehicle. This ensures that your truck is ideally prepared for operation as a heavy haulage vehicle, as the number of retrofit modifications is reduced. Longitudinal frame members with an appropriate overhang, frame reinforcements, the necessary steering and other components required for operation as a heavy haulage vehicle are selected.

Slider, Jost EV-HD 850, height 142 mm, 36 t¹⁾. This allows the distance between the rear axle and the fifth wheel kingpin to be changed. This enables adjustment to trailers with different swing radii while observing the permissible axle loads.



Heavy-duty fifth-wheel coupling. This fifth-wheel coupling allows the maximum fifth-wheel load of a four-axle tractor unit to be used.

Planetary hub reduction axles, 300 mm ring gear²⁾. The 13 t cast steel rear axle has a 300 mm ring gear, a differential as well as a planetary gear seat in each wheel hub and is therefore designed for very high loads. The two-stage transmission ensures that the maximum drive torque is applied directly to the wheel hubs. The cast iron axles have high ground clearance and a gross axle weight rating of up to 16 t.

Leading axle, 8 t, hydraulically steered. The hydraulically steered and optionally relievable leading axle with an 8 t load rating increases the fifth-wheel load of the vehicle. The adjustment is fully automatic in order to ensure optimum use



Stowage box stainless steel. The stowage box provides stowage space outside the cab for load-securing equipment and tools. Measuring 700 x 680 x 770 mm, it has a large capacity. Furthermore, it can support a load of up to 200 kg.

of the vehicle's capacity. When the vehicle is unladen, the tractive power at the drive axles can be increased briefly.



Advantages at a glance.

- Heavy-duty couplings¹⁾ front and rear for towing/pushing applications
- Highly task-oriented through different fifth-wheel couplings and mounting plates
- Frame reinforcement for best possible strength and stability
- Robust rear axles with an ultimate load of up to 16 t²⁾
- Hydraulically steered, air-suspended and optionally relievable leading axle for high traction and driving stability
- Additional stowage boxes¹⁾ on frame
- Ballast platform¹⁾ for high traction when working with drawbar trailer

¹⁾ Optional equipment.

²⁾ Special equipment for 6x4 and 8x4 vehicles.





Genuine Accessories meeting the highest standards.

The Actros is more than a truck. It is a workplace, a travelling companion, a living space. The comprehensive range of Mercedes-Benz Genuine Accessories is geared to this – and opens up a wide range of possibilities for meeting individual users' requirements.

Genuine accessories. The Actros offers working, living and sleeping comfort like virtually no other vehicle in the long-distance transport sector. With the genuine accessories you can lend it the perfect finishing touch and give it a very personal feel: for example, with detachable body parts in chrome and stainless steel for a highly distinctive look. Inside, too, our genuine accessories are able to meet practically every requirement with many extras, both large and small, which can make your daily work more enjoyable, more convenient, safer and more efficient. A comprehensive choice can be found in the current accessories catalogue and at your authorised Mercedes-Benz Dealer.



¹⁾ Not for the Actros up to 250 t.

Distinctive detail. The high-gloss polished stainless steel gills¹⁾ for the side panels express strength and dynamism – and accentuate the individual character of your Actros.

Extras for daily use.

Versatile, functional, attractive and motivating – all the Mercedes-Benz Genuine Accessories for the Actros contribute to making long-distance transport work easier and more enjoyable. Enjoy making your choice.

Roof lamp bracket. The roof lamp brackets¹⁾ are optimally matched to the shape of the cab in question, are made of high-gloss polished stainless steel and have space for up to four additional headlights. In this way you can improve the illumination ahead of your vehicle and give it a distinctive look.

Additional headlights. The main-beam headlights or work lamps provide optimal light distribution and improve visibility. Suitable for all Mercedes-Benz roof lamp brackets.

Chrome-finish mirror covers. The two-part set for the driver's and co-driver's side adds another highlight which gives your vehicle an even more charismatic and attractive appearance.

Pause bed set. Restful comfort with an attractive design. The quilt and pillow are filled with a pleasant polyester/cotton mixture – the covers are made from smooth, fine fabric and are washable at up to 60 °C.



Stylish appearance. The front chrome louvers give the distinctive, dynamic design of the Actros an even more expressive dimension.



Wheel nut caps. Because every detail counts: The stainless steel wheel nut cap protects the rim and the wheel nuts from damage and helps give the truck an individual look.

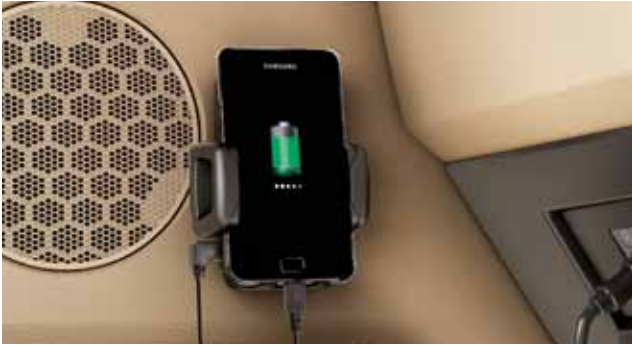

Mobile phone charging cradle. The universal charger cradle is suitable for many mobile phones. With the ex-factory pre-installation, it gives your mobile phone a secure place, charges it and increases comfort and convenience when telephoning.



Convenient and space-saving. The height-adjustable folding table finished in artificial leather is ideal for meals, for working on a laptop computer or for use as a convenient stowage tray.

¹⁾ Please observe country-specific legal requirements for the attachment and use of additional headlamps.



Back and neck support. The back/neck supports which are available individually provide effective relief in the lumbar/neck muscle region.



Side window wind deflector. The aerodynamically optimised tinted or clear side window deflector set for the driver's or co-driver's side protects against the airflow when driving with the windows open.



Advantages at a glance.

- Roof lamp bracket¹⁾ and additional headlights for enhanced visibility
- Chrome and stainless steel highlights for greater individuality and an impressive look
- Wheel nut cap and rear axle cap to protect rims and wheel nuts
- Universal charger cradle to hold and charge most popular mobile phones
- Practical folding table for working, eating and as an extra stowage facility
- High-quality bed sets for restful sleep
- Back and neck supports for relaxed, ergonomically correct sitting
- Side window wind deflectors to allow draft-free driving even when the window is open



Actros rigid – model overview				
Nominal Gross Vehicle Weight	18	18 (Volumer)	18 (CC) ¹⁾	20
Wheel configuration	4x2	4x2	4x2	4x2
Rear suspension	Air	Air	Air	Air
Engines				
OM 936				
175 kW (238 hp)	x	x	-	x
200 kW (272 hp)	x	x	-	x
220 kW (299 hp)	x	x	-	x
235 kW (320 hp)	x	x	-	x
260 kW (354 hp)	x	x	-	x
OM 470				
240 kW (326 hp)	x	x	x	x
265 kW (360 hp)	x	x	x	x
290 kW (394 hp)	x	x	x	x
315 kW (428 hp)	x	x	x	x
335 kW (455 hp)	x	x	x	x
OM 471				
310 kW (421 hp)	x	x	x	x
330 kW (449 hp)	x	x	x	x
350 kW (476 hp)	x	x	x	x
375 kW (510 hp)	x	-	-	x
390 kW (530 hp)	x	-	-	x
OM 473				
380 kW (517 hp)	x	-	-	x
425 kW (578 hp)	x	-	-	x
460 kW (625 hp)	x	-	-	x

25	25 (Volumer)	25	26	26	33
6x2 single trailing axle	6x2 single trailing axle	6x2/4	6x4	6x2 double trailing axle	6x4
Air	Air	Air	Air	Air	Air
-	-	-	-	-	-
x	x	x	x	x	-
x	x	x	x	x	-
x	x	x	x	x	-
x	x	x	x	x	-
x	x	x	x	x	x
x	x	x	x	x	x
x	x	x	x	x	x
x	x	x	x	x	x
x	x	x	x	x	x
x	x	x	x	x	x
x	x	x	x	x	x
x	x	x	x	x	x
x	-	-	x	x	x
x	-	-	x	x	x
x	-	-	x	x	x

x Available - Not available ¹⁾ Car transporter.

Actros rigids – model overview				
Nominal Gross Vehicle Weight	18	18 (Volumer)	18 (CC) ¹¹	20
Wheel configuration	4x2	4x2	4x2	4x2
Rear suspension	Air	Air	Air	Air
Wheelbase				
3250 mm	-	-	-	-
3550 mm	-	-	-	-
3700 mm	x ²⁾	-	-	x
3850 mm	-	-	-	-
4000 mm	x ²⁾	-	-	x
4150 mm	-	-	-	-
4300 mm	x ²⁾	-	-	x
4600 mm	x ²⁾	-	-	x
4900 mm	x ²⁾	x ^{3) 4)}	-	x
5200 mm	x ²⁾	-	-	x
5500 mm	x ²⁾	x ^{3) 4)}	x ^{3) 4)}	x
5800 mm	x ²⁾	x ^{3) 4)}	x ^{3) 4)}	x
6100 mm	x ²⁾	-	-	x
6400 mm	x ²⁾	-	-	x
6700 mm	x ²⁾	x ^{3) 4)}	-	x
Cab variants				
CompactSpace L-cab, 170 mm tunnel	-	x	x ⁷⁾	-
CompactSpace L-cab, 320 mm tunnel	-	-	x ⁸⁾	-
ClassicSpace L-cab, 170 mm tunnel	x ⁷⁾	x ⁷⁾	x	x ⁷⁾
ClassicSpace L-cab, 320 mm tunnel	x ⁸⁾	x ⁸⁾	x ⁸⁾	x ⁸⁾
ClassicSpace L-cab, level floor	x ⁹⁾	x ⁹⁾	-	x ⁹⁾
StreamSpace L-cab, 2300 mm wide, 320 mm tunnel	x ⁸⁾	x ⁸⁾	-	x ⁸⁾
StreamSpace L-cab, 2300 mm wide, 170 mm tunnel	x	x	x	x
StreamSpace L-cab, 2300 mm wide, level floor	x ⁹⁾	x ⁹⁾	-	x ⁹⁾
StreamSpace L-cab, 2500 mm wide, level floor	x ⁹⁾	x ⁹⁾	x	x ⁹⁾
BigSpace L-cab	x ⁹⁾	x ⁹⁾	x	x ⁹⁾
GigaSpace L-cab	x ⁹⁾	x ⁹⁾	x	x ⁹⁾

25	25 (Volumer)	25	26	26	33
6x2 single trailing axle	6x2 single trailing axle	6x2/4	6x4	6x2 double trailing axle	6x4
Air	Air	Air	Air	Air	Air
-	-	x ⁶⁾	-	-	-
-	-	x ⁶⁾	-	-	-
-	-	-	x	-	x
-	-	x ⁶⁾	-	-	-
x ⁵⁾	x ^{4) 6)}	-	x	x	x
-	-	x ⁶⁾	-	-	-
x ⁵⁾	x ^{4) 6)}	-	x	x	x
x ⁵⁾	x ^{4) 6)}	-	x	x	x
x ⁵⁾	x ^{4) 6)}	-	x	x	x
x ⁵⁾	x ^{4) 6)}	-	x	x	x
x ⁵⁾	x ^{4) 6)}	-	x	x	x
x ⁵⁾	x ^{4) 6)}	-	x	x	x
x ⁵⁾	-	-	-	x	-
-	-	-	-	-	-
-	-	-	-	-	-
-	x	-	-	-	-
-	-	-	-	-	-
x ⁷⁾	x ⁷⁾	x ⁷⁾	x ⁷⁾	x ⁷⁾	x ⁷⁾
x ⁸⁾	x ⁸⁾	x ⁸⁾	x ⁸⁾	x ⁸⁾	x ⁸⁾
x ⁹⁾	x ⁹⁾	x ⁹⁾	x ⁹⁾	x ⁹⁾	x ⁹⁾
x ⁸⁾	x ⁸⁾	x ⁸⁾	x ⁸⁾	x ⁸⁾	x ⁸⁾
x	x	x	x	x	x
x ⁹⁾	x ⁹⁾	x ⁹⁾	x ⁹⁾	x ⁹⁾	x ⁹⁾
x ⁹⁾	x ⁹⁾	x ⁹⁾	x ⁹⁾	x ⁹⁾	x ⁹⁾
x ⁹⁾	x ⁹⁾	x ⁹⁾	x ⁹⁾	x ⁹⁾	x ⁹⁾
x ⁹⁾	x ⁹⁾	x ⁹⁾	x ⁹⁾	x ⁹⁾	x ⁹⁾

x Available - Not available ¹⁾ Car transporter. ²⁾ Also as Actros Loader with engines from **175 kW** (238 hp) to **315 kW** (428 hp) (OM 936 und OM 470 only). ³⁾ With engines from **175 kW** (238 hp) to **350 kW** (476 hp).
⁴⁾ Low-frame vehicle only with front and rear air suspension ⁵⁾ Also as Actros Loader with engines from **220 kW** (299 hp) bis **315 kW** (428 hp) (OM 936 und OM 470 only). ⁶⁾ With engines from **200 kW** (272 hp) to **375 kW** (510 hp).
⁷⁾ Standard for OM 471 and OM 473. ⁸⁾ Not in conjunction with OM 471 and OM 473. ⁹⁾ Not in conjunction with OM 936.

Actros tractor units – model overview					
Nominal Gross Vehicle Weight	18	18 (Volumer)	18 (Volumer) ¹⁾	18 (CC) ²⁾	20
Wheel configuration	4x2	4x2	4x2	4x2	4x2
Rear suspension	Air	Air	Air	Air	Air
Engines					
OM 936					
175 kW (238 hp)	x	x	x	–	x
200 kW (272 hp)	x	x	x	–	x
220 kW (299 hp)	x	x	x	–	x
235 kW (320 hp)	x	x	x	–	x
260 kW (354 hp)	x	x	x	–	x
OM 470					
240 kW (326 hp)	x	x	x	x	x
265 kW (360 hp)	x	x	x	x	x
290 kW (394 hp)	x	x	x	x	x
315 kW (428 hp)	x	x	x	x	x
335 kW (455 hp)	x	x	x	x	x
OM 471					
310 kW (421 hp)	x	x	x	x	x
330 kW (449 hp)	x	x	x	x	x
350 kW (476 hp)	x	x	x	x	x
375 kW (510 hp)	x	–	–	–	x
390 kW (530 hp)	x	–	–	–	x
OM 473					
380 kW (517 hp)	x	–	–	–	x
425 kW (578 hp)	x	–	–	–	x
460 kW (625 hp)	x	–	–	–	x

Actros tractor units – model overview					
Nominal Gross Vehicle Weight	18	18 (Volumer)	18 (Volumer) ¹⁾	18 (CC) ²⁾	20
Wheel configuration	4x2	4x2	4x2	4x2	4x2
Rear suspension	Air	Air	Air	Air	Air
Wheelbase					
2650 mm	-	-	-	-	-
2990 mm	-	-	-	-	-
3250 mm	-	-	-	-	-
3400 mm	-	-	-	-	-
3550 mm	x	-	-	-	x
3700 mm	x ³⁾	x ^{4) 5)}	x ^{4) 5)}	-	x
3850 mm	x ³⁾	-	-	x ⁵⁾	x
4000 mm	x ³⁾	-	-	-	x
Cab variants					
CompactSpace L-cab, 170 mm tunnel	-	-	x	x ⁷⁾	-
CompactSpace L-cab, 320 mm tunnel	-	-	-	x ⁸⁾	-
ClassicSpace L-cab, 170 mm tunnel	x ⁷⁾	x	x ⁷⁾	x	x ⁷⁾
ClassicSpace L-cab, 320 mm tunnel	x ⁸⁾	-	x ⁸⁾	x ⁸⁾	x ⁸⁾
ClassicSpace L-cab, level floor	x ⁹⁾	x ⁹⁾	x ⁹⁾	-	x ⁹⁾
StreamSpace L-cab, 2300 mm wide, 320 mm tunnel	x ⁸⁾	-	x ⁸⁾	-	x ⁸⁾
StreamSpace L-cab, 2300 mm wide, 170 mm tunnel	x	x	x	x	x
StreamSpace L-cab, 2300 mm wide, level floor	x ⁹⁾	x ⁹⁾	x ⁹⁾	-	x ⁹⁾
StreamSpace L-cab, 2500 mm wide, level floor	x ⁹⁾	x ⁹⁾	x ⁹⁾	-	x ⁹⁾
BigSpace L-cab	x ⁹⁾	x ⁹⁾	x ⁹⁾	-	x ⁹⁾
GigaSpace L-cab	x ⁹⁾	x ⁹⁾	x ⁹⁾	-	x ⁹⁾

24	25	25	25	26	26	33
6x2/2	6x2 single trailing axle	6x2/2	6x2/4	6x4	6x2 double trailing axle	6x4
Air	Air	Air	Air	Air	Air	Air
-	-	x ³⁾	x	-	-	-
x ³⁾	-	-	-	-	-	-
-	x ⁶⁾	-	-	x	x ⁶⁾	x
-	x ⁶⁾	-	-	x	x ⁶⁾	x
-	x	-	-	x	x	x
-	-	-	-	-	-	-
-	-	-	-	-	-	-
-	-	-	-	x	-	x
-	-	-	-	-	-	-
-	-	-	-	-	-	-
x ⁷⁾	x ⁷⁾	x ⁷⁾	x ⁷⁾	x ⁷⁾	x ⁷⁾	x ⁷⁾
x ⁸⁾	x ⁸⁾	x ⁸⁾	x ⁸⁾	x ⁸⁾	x ⁸⁾	x ⁸⁾
x ⁹⁾	x ⁹⁾	x ⁹⁾	x ⁹⁾	x ⁹⁾	x ⁹⁾	x ⁹⁾
x ⁸⁾	x ⁸⁾	x ⁸⁾	x ⁸⁾	x ⁸⁾	x ⁸⁾	x ⁸⁾
x	x	x	x	x	x	x
x ⁹⁾	x ⁹⁾	x ⁹⁾	x ⁹⁾	x ⁹⁾	x ⁹⁾	x ⁹⁾
x ⁹⁾	x ⁹⁾	x ⁹⁾	x ⁹⁾	x ⁹⁾	x ⁹⁾	x ⁹⁾
x ⁹⁾	x ⁹⁾	x ⁹⁾	x ⁹⁾	x ⁹⁾	x ⁹⁾	x ⁹⁾
x ⁹⁾	x ⁹⁾	x ⁹⁾	x ⁹⁾	x ⁹⁾	x ⁹⁾	x ⁹⁾

x Standard - Not available ¹⁾ Low Deck. ²⁾ Car transporter. ³⁾ Also as Actros Loader with engines from **235 kW** (320 hp) bis **315 kW** (428 hp) (OM 936 und OM 470 only). ⁴⁾ With engines from **175 kW** (238 hp) to **350 kW** (476 hp). ⁵⁾ Low-frame vehicle only with front and rear air suspension. ⁶⁾ Not in conjunction with OM 473. ⁷⁾ Standard for OM 471 and OM 473. ⁸⁾ Not in conjunction with OM 471 and OM 47. ⁹⁾ Not in conjunction with OM 936.

Actros up to 250 tonnes – model overview		
Nominal Gross Vehicle Weight	33	41
Wheel configuration	6x4	8x4/4
Rear suspension	Air	Air
Engine variants OM 473		
380 kW (517 hp)	x	x
425 kW (578 hp)	x	x
460 kW (625 hp)	x	x
Wheelbase		
3300 mm	x	x ¹⁾
3900 mm	x	x
Cab variants		
BigSpace L-cab	x	x
GigaSpace L-cab	x	x

x Available – Not available ¹⁾ For semi-heavy vehicles only.

Engine performance data

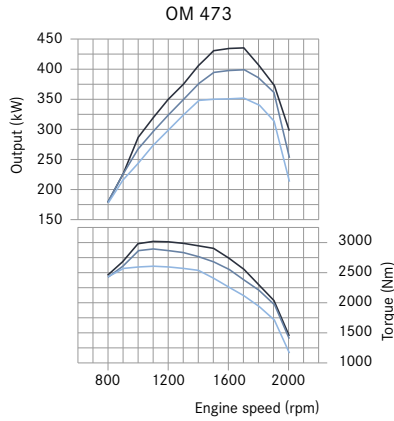

6-cylinder in-line, 15.6 l displacement

kW (hp)	Nm
at 1600 rpm	at 1100 rpm
380 (517)	2600
425 (578)	2800
460 (625)	3000

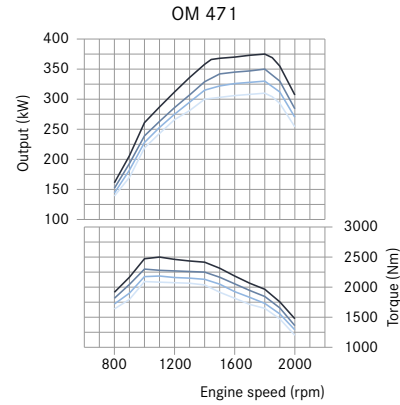

6-cylinder in-line, 12.8 l displacement

kW (hp)	Nm
at 1800 rpm	at 1100 rpm
310 (421)	2100
330 (449)	2200
350 (476)	2300
375 (510)	2500 ¹⁾

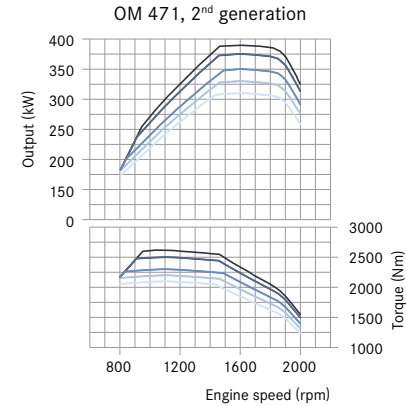

6-cylinder in-line, 12.8 l displacement

kW (hp)	Nm
at 1600 rpm	at 1100 rpm
310 (421)	2100
330 (449)	2200
350 (476)	2300
375 (510)	2500 ¹⁾
390 (530)	2600

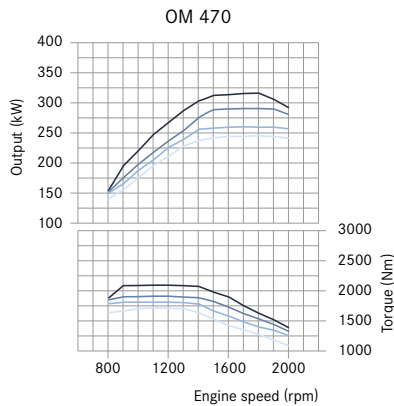

6-cylinder in-line, 10.7 l displacement

kW (hp)	Nm
at 1800 rpm	at 1100 rpm
240 (326)	1700
265 (360)	1800
290 (394)	1900
315 (428)	2100

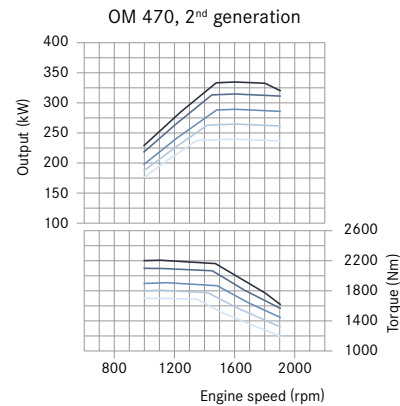

6-cylinder in-line, 10.7 l displacement

kW (hp)	Nm
bei 1600 rpm	at 1100 rpm
240 (326)	1700
265 (360)	1800
290 (394)	1900
315 (428)	2100
335 (455)	2200

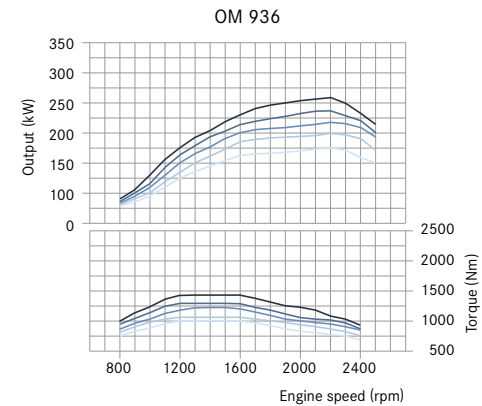

6-cylinder in-line, 7.7 l displacement

kW (hp)	Nm
bei 2200 rpm	at 1200-1600 rpm
175 (238)	1000
200 (272)	1100
220 (299)	1200
235 (320)	1300
260 (354)	1400

The Euro VI engines: sustainable technology, up to **460 kW** (625 hp) of power and peak torque of 3000 Nm. The Actros up to 250 tonnes GCW is available exclusively with the engines of the 15.6-litre class (OM 473).

¹⁾ Vehicles with normal frame height in conjunction with rear axle ratios of $i = 2.611$ and $i = 2.533$ in 12th gear.

The Actros up to 44 t – tank variants

Actros tank variants. Flexible combination options – within the same tank cross-section different tank capacities can be combined on the left and right-hand side. This applies to diesel and AdBlue® tanks as well as to combination tanks. The illustrations show two possible variants on tractor units with a component-carrier rear end.



Modular system – tanks. To meet individual requirements, the Actros up to 44 t can be equipped with tanks of differing heights and widths.

Tank example for the Actros 4x2 tractor unit, (3700 mm wheelbase): 1300 l diesel, 90 l AdBlue®. Tank capacity of 1420 l available for wheelbase of 3850 mm and higher – on the left: 880 l diesel and 90 l AdBlue®, on the right: 540 l diesel.



- 1 High/wide combination tank, 820 l diesel, 90 l AdBlue®
- 2 Auxiliary tank on rhs wide/high 480 l diesel
- 3 Exhaust gas aftertreatment system
- 4 Battery

Tank example for the Actros Volumer 4x2 tractor unit (wheelbase 3700 mm: 990 l diesel, 75 l AdBlue®)



- 1 Wide/low combination tank, 660 l diesel, 75 l AdBlue®
- 2 Auxiliary tank on rhs wide/low 330 l diesel
- 3 Exhaust gas aftertreatment system
- 4 Battery

The Actros – cab variants

Cab variants. With a total of eleven cab variants, the Actros ensures excellent working, living and sleeping comfort. This is what characterises the GigaSpace L-cab for example, with its headroom of 2.13 m and the SoloStar Concept. In addition to the 2500 mm wide variants with a level floor, the 2300 mm wide variants are also available with a level floor throughout¹⁾. The Actros up to 250 tonnes GCW is available exclusively with the GigaSpace or BigSpace cab variants.

¹⁾ Level floor as an option for cabs with width of 2300 mm.

GigaSpace L-cab

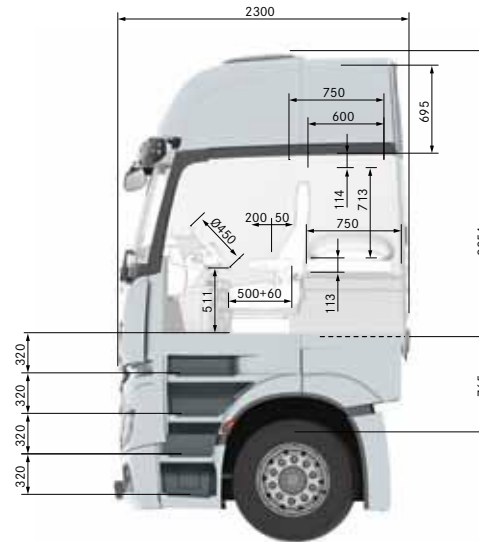

Headroom between the seats: 2130 mm
Headroom in front of the seats: 2050 mm

BigSpace L-cab.

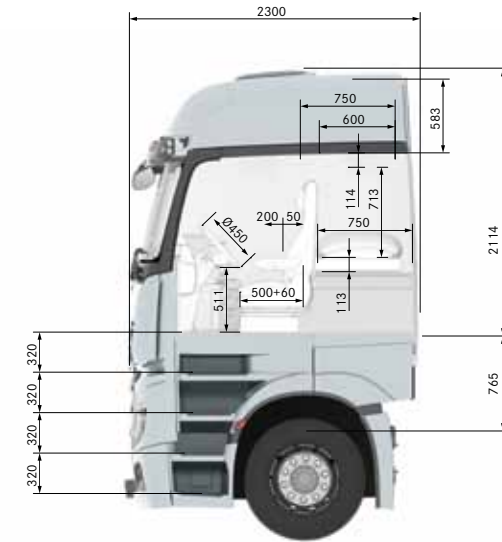

Headroom between the seats: 1990 mm
Headroom in front of the seats: 1910 mm

General technical information.

Exterior width:

GigaSpace, BigSpace and StreamSpace cab (1) 2500 mm
All ClassicSpace, CompactSpace and StreamSpace cabs (2, 3, 4) 2300 mm

Exterior length:

All cabs 2300 mm

GigaSpace L-cab with SoloStar Concept

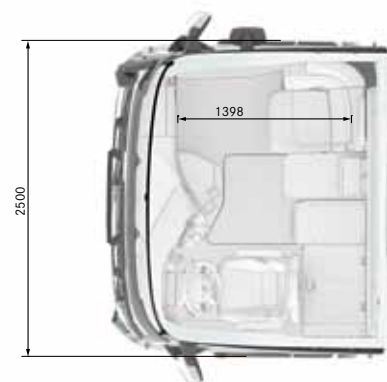

L-cab exterior width 2500 mm



StreamSpace L-cab (1)
(exterior width 2500 mm)

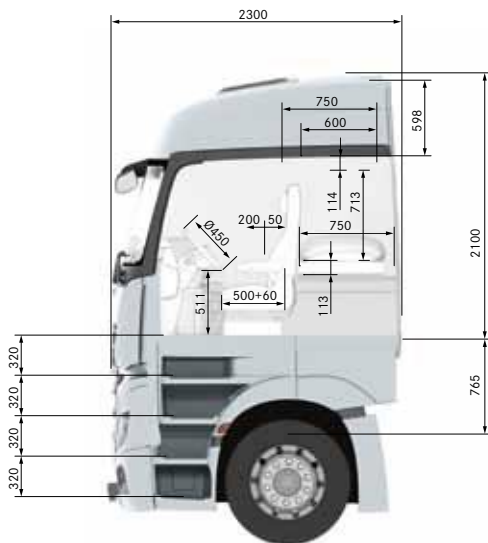

Headroom between the seats: 1970 mm
Headroom in front of the seats: 1830 mm

StreamSpace L-cab (2)
(exterior width 2300 mm, level floor)

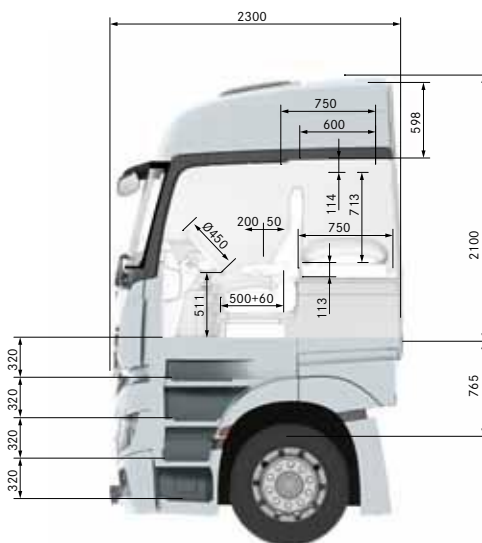

Headroom between the seats: 1970 mm
Headroom in front of the seats: 1840 mm

StreamSpace L-cab (3)
(exterior width 2300 mm, engine tunnel)

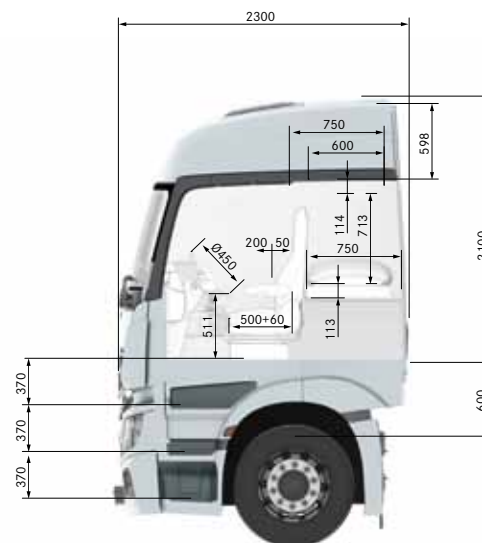

Engine tunnel: 170 mm
Headroom on engine tunnel: 1785 mm
Headroom in front of the seats: 1840 mm

L-cab Exterior width 2300 mm



Not shown: StreamSpace L-cab (4)
Engine tunnel: 320 mm
Headroom on engine tunnel: 1635 mm
Headroom in front of the seats: 1840 mm

ClassicSpace L-cab (2)
 (exterior width 2300 mm, engine tunnel)

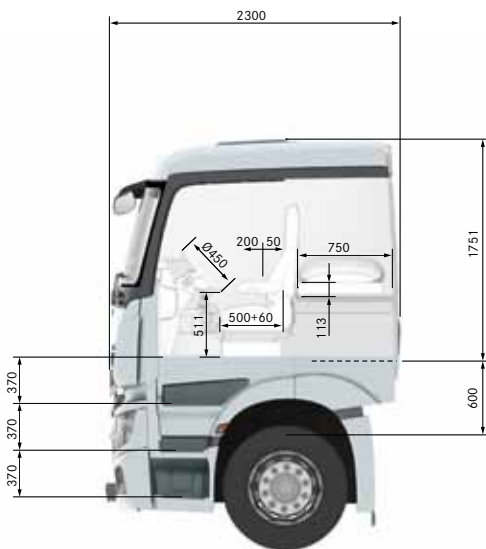

Engine tunnel: 170 mm
 Headroom on engine tunnel: 1460 mm
 Headroom in front of the seats: 1590 mm

Not shown: ClassicSpace level floor (1)
 Headroom between the seats: 1640 mm
 Headroom in front of the seats: 1590 mm

Not shown: ClassicSpace L-cab (3)
 Engine tunnel: 320 mm
 Headroom on engine tunnel: 1310 mm
 Headroom in front of the seats: 1600 mm

Not shown: CompactSpace L-cab (1)
 Engine tunnel: 170 mm
 Headroom on engine tunnel: 1215 mm
 Headroom in front of the seats: 1397 mm

Not shown: CompactSpace L-cab (2)
 Engine tunnel: 320 mm
 Headroom on engine tunnel: 1065 mm
 Headroom in front of the seats: 1397 mm

Please note: changes may have been made to the product since going to press (20.05.2016). The manufacturer reserves the right to make changes to the design, form, colour and specification during the delivery period, provided these changes, while taking into account the interests of the vendor, can be deemed reasonable with respect to the purchaser. Where the vendor or the manufacturer uses symbols or numbers to describe an order or the subject of an order, no rights may be derived solely from these. The illustrations and texts may include accessories and optional extras which do not form part of the standard specification. Colours may differ slightly from those shown in the brochure, owing to the limitations of the printing process. The images shown are to be considered examples only and do not necessarily reflect the actual state of the original vehicles. The appearance of the original vehicles may differ from these illustrations. Subject to change. This brochure may also contain models and services which are not available in certain countries. This brochure is distributed internationally. It provides a general indication of the range of models, features, special equipment and/or colours available in various countries. Some of the models, features, special equipment and/or colours may not be available in your country, or may only be available in a different specification. Additionally some models, features, special equipment and/or colours may only be available in combination with others. For current and more specific information in relation to the range of models, features, special equipment and/or colours available in your country, and their pricing, you should contact your nearest authorised Mercedes-Benz Truck Dealer.

www.mbtrucks.co.uk/actros